

- 1
- 2
- 3
- 4
- 5
- 6

7

# Workplace systems

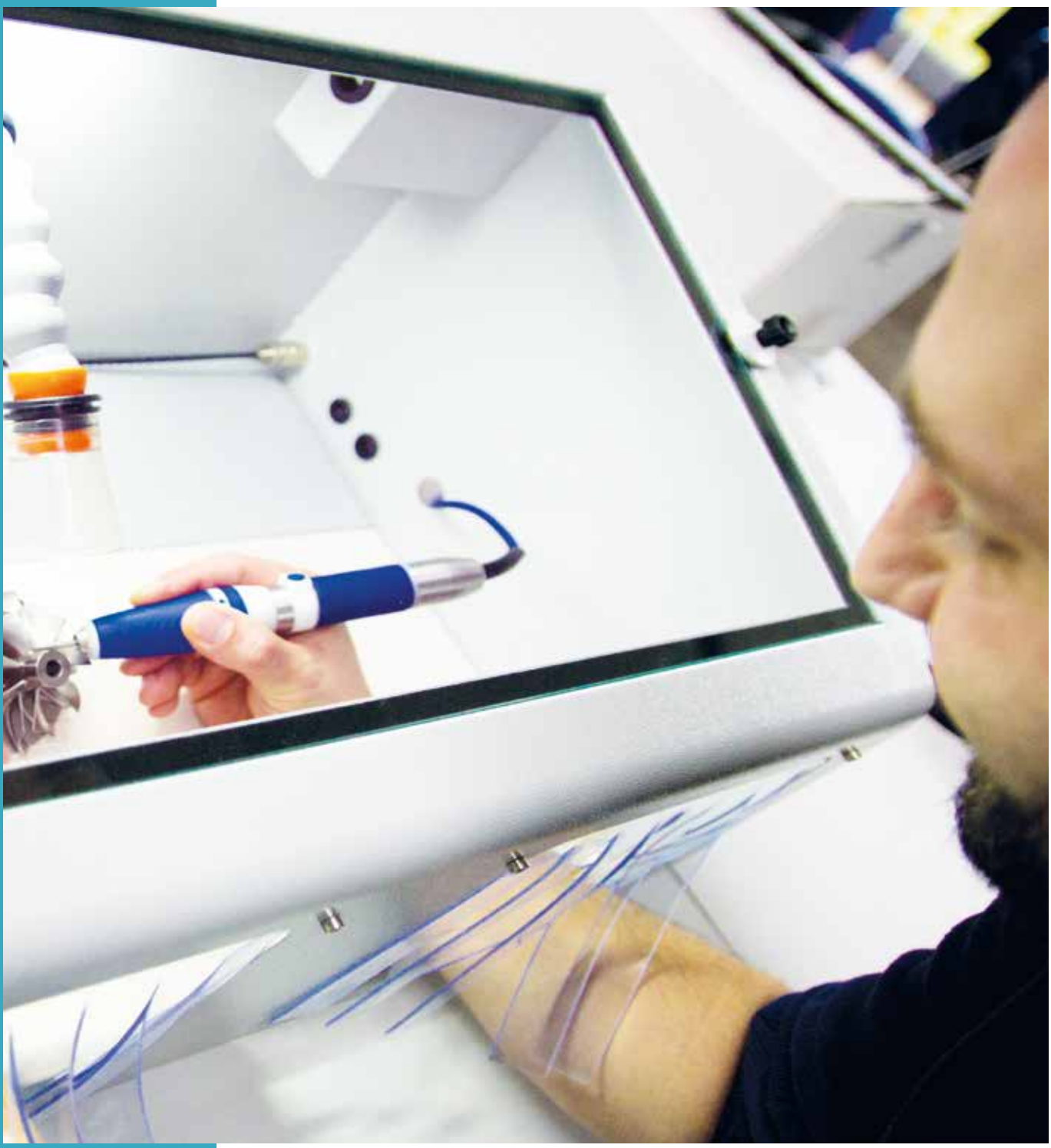

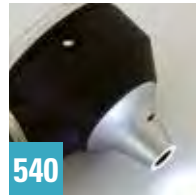
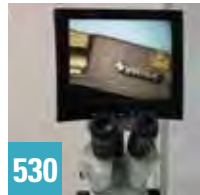
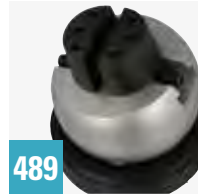

**468 Workshop equipment** .....

Worktables and Stands | Work chairs | Clamping devices | Workplace lighting | Cleaning, polishing & caring | Precision impression | Cutting oils and sprays | Hand, ear, eye and breathing protection | Surface protection | Precision gauge tapes | Assortment case | Suction units | Deburring box

**520 Microscopes and control tools** .....

Stereomicroscopes | Digital picture storage | Cold light sources | Magnifying glasses and loupes

**536 Inspection systems** .....

Inspection systems 2500 | USB / WiFi Digital Microscope

NEW!

ErgoWork plus

**Worktable – ergonomic, solid, comfortable.**



- 1
- 2
- 3
- 4
- 5
- 6

7

**NEW!**

## Worktable joke Ergo-Work plus Basic module and options

### Comfortable, efficient and safe

We would like you to work at modern workplaces. Workplaces that offer you comfort and make your work a good deal easier. Workplaces that adapt to your needs and consciously avoid damage to health by fulfilling ergonomic requirements. The back of the table for example features a 160 mm-wide integrated T-slot plate providing you very versatile clamping options.

### Workplaces made by joke

ErgoWork workplaces combine practical requirements with modern ergonomics. The result is a modular worktable design which, although it cannot do the work for you, makes it noticeably pleasanter and more efficient. Working with first-rate "hardware" is ultimately a great deal more enjoyable and your body will thank you for it at any rate.

	Order No.	Price from 1 piece
<b>ErgoWork plus worktable (basic module)</b>		
		
Dimensions (W x H x D):	1,000 x 1,950 x 750 cm	<b>0 200 360</b>
Tabletop dim.:	1,000 x 750 mm	
Height adjustment:	660 to 1,060 mm, continuous	
Max. load:	150 kg (centre of lifting column)	
Supply voltage:	230 V, 50/60 Hz	
Connected load:	400 W (excl. accessories)	
Scope of delivery:	excl. accessories and pivot unit	

Many options for equipping your workplace  
check out accessories list on the next double page

**NEW!**

## Innovative workplace lighting SunLike

### Light makes all the difference!

The light is modelled on the natural spectrum of sunlight, which means it not only offers a better visual effect, but also greater colour fidelity. The LED technology is so bright and lifelike that reflected glare is virtually eliminated and objects look clearer and more starkly contrasted.

	Order No.	Price from 1 piece
<b>SunLike workplace light</b>		
		
Special LEDs with daylight-like spectrum		<b>0 200 365</b>
Nominal output:	63 W	
Colour temperature:	4,000 K	
Lamp service life:	approx. 50,000 hours	
Brightness:	dimnable by multifunction switch	
Dimensions:	900 mm x 122.16 mm x 42 mm	
Supply voltage:	220 - 240 V(AC), 50/60 Hz	
Light current:	4,351 lm	
Illuminance:	1,805 Lux (1 m distance)	
Degree of protection:	IP 30	
Operating temperature:	0 to 30°C	

Accessories required:  
see next double page

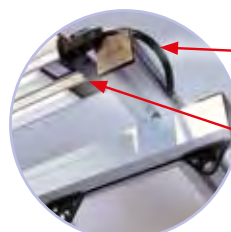

**0 200 365-2** Connection cable

**0 200 365-1** Mounting bracket



## Various options for your individual workplace

Vary your workstation height and depth with the help of the many options. joke offers the following components:



**0 200 367** Shelf, V2A stainless steel  
incl. 2 x mounting brackets  
and profile rail 300 mm



various profile rails (40 x 40 mm):  
**0 200 385-1** rail, 900 mm length  
**0 200 385-2** rail, 450 mm length

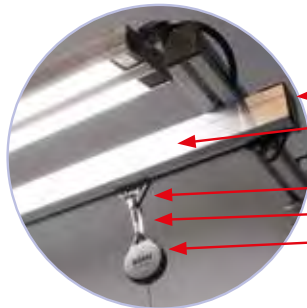

**0 200 388** Tool hanger end bracket  
**0 200 386** Tool hanger profile rail  
**0 200 387** Tool hanger slide  
**0 200 389** Snap hook for tool slide  
**0 200 370** Spring balancer



**0 200 385** Portal superstructure, series 40,  
with:  
2 x Profile rails, 40 x 40, 900 mm  
2 x Profile rails, 40 x 40, 450 mm  
8 x Mounting brackets



**0 200 366** Pivot arm with shelf  
300 x 200 mm



**2 017 751**  
Socket strip, 6-point



**0 200 383** Hand switch  
**0 200 382** Drawer for  
hand switch



or  
**0 200 384** Foot switch



**0 200 365-2** Workplace light  
connecting lead  
**0 200 365-1** Workplace light  
mounting bracket

# Worktable joke Ergo-Work plus

## Options and accessories

	Dimensions	Order No.	Price from 1 piece
<b>Socket strip, 6 -point</b>			
		<b>2 017 751</b>	
<b>Shelf, V2A stainless steel</b>			
	420 x 200 mm	<b>0 200 367</b>	
<b>Hand switch for ErgoWork plus worktable</b>			
		<b>0 200 383</b>	
<b>Drawer for hand switch</b>			
		<b>0 200 382</b>	
<b>Foot switch for ErgoWork plus worktable</b>			
		<b>0 200 384</b>	
<b>Pivoting arm with shelf</b>			
	300 x 200 mm	<b>0 200 366</b>	
<b>Tool hanger end bracket</b>			
		<b>0 200 388</b>	
<b>Tool hanger profile rail</b>			
	1,100 mm	<b>0 200 386</b>	
<b>Tool hanger slide</b>			
		<b>0 200 387</b>	
<b>Snap hook for tool slide</b>			
		<b>0 200 389</b>	
<b>Spring balancer</b>			
		<b>0 200 370</b>	
<b>Workplace light connecting lead</b>			
		<b>0 200 365-2</b>	
<b>Workplace light mounting bracket</b>			
		<b>0 200 365-1</b>	
<b>SunLike workplace light</b>			
		<b>0 200 365</b>	
<b>Portal superstructure</b>			
	40 x 40 x 900 mm	<b>0 200 385</b>	
<b>Profile rail 40 x 40 mm, 900 mm long</b>			
	40 x 40 x 900 mm	<b>0 200 385-1</b>	
<b>Profile rail 40 x 40 mm, 450 mm long</b>			
	40 x 40 x 450 mm	<b>0 200 385-2</b>	

# Worktable joke JT

## Worktable joke JT 400

The worktable enables ergonomic work through electric height adjustment.

- Load-bearing capacity 400 kg
- Electric height adjustment between 650 and 1,280 mm
- Speed of 23 mm/sec.
- Memory control
- Ideal for use in the industrial sector and the electronic and pharmaceutical industry
- Electrical connection 230 V / 50 Hz

### Optionally available:

- On castors
- Heavy-duty table
- Perforated walls
- Power strips
- Base cabinet



Price from

Order No.

1 piece

### Worktable JT 400 with beech Multiplex tabletop 40 mm



Number of lifting jack columns: 4  
 Lifting system: Electric  
 Operator control element: Up / Down memory control  
 Load-bearing capacity kg: 400  
 Max. speed without load: 23 mm/sec.  
 Stroke length: 630 mm  
 Dimensions (W x D): 2,000 x 750 mm

0 200 847-7



Number of lifting jack columns: 4  
 Lifting system: Electric  
 Operator control element: Up / Down memory control  
 Load-bearing capacity kg: 400  
 Max. speed without load: 23 mm/sec.  
 Stroke length: 630 mm  
 Dimensions (W x D): 1,500 x 750 mm

0 200 848-7

## Standing aid

### Standing aid

Even if you prefer to stand whilst working instead of sitting down – you still need the necessary support. Our standing aid relieves you during stand-up jobs resulting in enhanced efficiency with fewer inactivity periods due to injuries caused by poor posture.

- Integral foam padding
- Seat inclination 2–15° forwards
- Circular base with PU rim (anti-slip)
- Seat height adjustment by means of a pneumatic safety spring
- optimal as a supplement for your workplace

			Price from
			1 piece
			Order No.
<b>Standing aid</b>			
Seat height:	630 – 850 mm		<b>0 200 419</b>
Seat surface (W x D):	390 x 350 mm		
Circular base:	Ø 430 mm		



## Work chairs

### Work chairs

The fact that healthy, proper sitting posture is a prerequisite for an ergonomic workplace is no secret in today's working world. Yet only very few companies pay attention to this basic principle.

Our joke work chairs actively contribute to maintaining your health. The contact backrest with adjustable pressure constantly adapts to your sitting position and ensures that your spine is supported in every position. Our contribution to active prevention of back injuries: take a seat, please.

- Adjustable backrest pressure
- Backrest inclination 10° in both directions
- Seat inclination 7° forwards, 4° rearwards
- Integral foam upholstery
- Seat height adjustment by means of a pneumatic safety spring
- Circular base with PU rim (anti-slip) for a secure hold

			Price from
			1 piece
			Order No.
<b>Work chair joke Standard</b>			
	Seat height:	450 – 630 mm	<b>0 200 413</b>
	Seat surface (W x D):	460 x 435 mm	
	Circular base:	Ø 430 mm	



			Price from
			1 piece
			Order No.
<b>Work chair joke Extra-high</b>			
	Seat height:	630 – 880 mm	<b>0 200 414</b>
	Seat surface (W x D):	460 x 435 mm	
	Circular base:	Ø 560 mm	





## Positioner joke easy-Work for attachment to table

### Positioner joke easy-Work

Compact and very flexible to use: the small rotating and pivoting unit unit joke easy-Work can be attached quickly and securely to almost any table by means of the drillings, such as the large joke Ergo-Work worktable.

The optionally available T-slot clamping plates ensure make fixing the workpieces child's play. These plates are made from aluminium and are optionally available in square or round shape.



360° rotation range

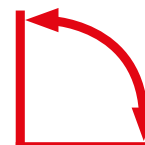

90° pivot range

Price from

Order No.

1 piece

### joke easy-Work positioner with magnet Ø 125 mm



Rotation range: manually through 360°  
Pivoting range: 0 – 90° manually  
Dimensions (W x H x D): 200 x 160 x 250 mm  
Weight: approx. 11 kg  
Clamping system: Magnet Ø 125 mm

0 200 872

Price from

Order No.

1 piece

### joke easy-Work positioner with T-slot clamping plate, round





Rotation range: 360° manual  
Pivoting range: 0 – 90° manual  
Dimensions (W x H x D): 250 x 130 x 250 mm  
Weight: approx. 8 kg  
Clamping system: T-slot clamping plate, Ø 248 mm

0 200 873



# Clamping table joke DS 200 / 200-E

With 200 mm mounting plate - also for mounting an optional clamping magnet (item no. 0 200 316).  
Clamping disc with M6 grid holes for mechanical clamping without magnetic chuck.  
Incl. 4 stepped jaws and 4 clamping irons

		Order No.	Price from 1 piece
<b>Clamping table joke DS 200</b>			
	Dimensions base plate:	250 x 280 mm	<b>0 200 302</b>
	Max. Load:	20 kg, horizontal	
	Weight:	9 kg	
	Rotation range:	360° manual	
	Swivel range:	0–100° via gear	

		Order No.	Price from 1 piece
<b>Clamping table joke DS 200-E</b>			
	Dimensions base plate:	250 x 280 mm	<b>0 200 303</b>
	Weight:	12 kg	
	Rotation range:	360° via motor, Speed 0.5-9 rpm	
	Swivel range:	0–90° via gear	

## Accessories / spare parts

		Order No.	Price from 1 piece
<b>Foot control for DS 200-E and DS 400-E</b>			
	2-button foot switch	<b>0 200 301-6</b>	
	Left button:		Start/Stop rotation
	Right key:		Change of direction of rotation
<b>Round magnet for joke DS 200 clamping table</b>			
	Ø 130 mm	<b>0 200 316</b>	
	80 N/cm <sup>2</sup>		
<b>Three-jaw chuck Ø 125 mm</b>			
	Clamping:	Ø 4–125 mm	<b>0 200 320-1</b>
	Pitch circle:	Ø 108 mm	
	Number of bores:	3 x M8	
	Total height with jaws:	85 mm	
	Total height without jaws:	58 mm	

# Clamping table

## joke DS 400 / 400-E

**NEW!**

### Clamping table joke DS 400

Workpieces weighing up to 50 kg can be reliably clamped horizontally on the precision clamping table, swivelled between 0° and 90° and rotated through 360° using the turntable. The turntable lock and the swivelling drive with self-locking mechanism hold the workpiece securely in any working position. The optionally available mounting plate (Art. No. 0200 301-5) is equipped with grid holes that can be used to hold almost all workpiece geometries with clamping devices without any problems. A powerful round magnet (item no. 0 200 314) is also available as an accessory, which is mounted directly onto the mounting plate (item no. 0200 301-5) using machine screws.



		Price from
		Order No. 1 piece
<b>Clamping table joke DS 400</b>		
For mounting magnetic chuck or 400 mm mounting plate (optionally available, see accessories).		<b>0 200 304</b>
Rotation range:	360° manual,	
swivelling range:	0-100° manual	
Dimensions:	700 x 550 mm	
Weight:	25 kg	

 *Accessories / spare parts  
see page 477*

# Clamping table

## joke DS 400 / 400-E

**NEW!**

### Clamping table joke DS 400-E

The clamping table can be rotated and swivelled, automatically rotated by motor drive and has a sturdy stand with fixing elements. Speed and direction of rotation are selectable. Can be used with a clamping plate or magnet.

		Order No.	Price from 1 piece
<b>Clamping table joke DS 400-E</b>			
Rotation range:	360° via motor	<b>0 200 301</b>	
Rotation speed:	0.25–20 rotations per minute preset to max. 10 rpm		
Swivel range:	0–90° via gear		
Max. load:	50 kg		
Dimensions:	700 x 530 x 500 mm		
Weight:	36 kg		
Power supply CEE:	3 x 440 V 50 Hz		
Power:	0.37 kW		



### ⚙️ Accessories / spare parts

		Dimensions	Clamping force	Order No.	Price from 1 piece
<b>Round magnet for joke DS 300 and DS 400 clamping table</b>					
		Ø 160 x 50 mm	80 N/cm <sup>2</sup>	<b>0 200 314</b>	
<b>Mounting plate for DS 400-E and DS 400</b>					
		Ø 400 x 12 mm		<b>0 200 301-5</b>	
		slots: 10.5 mm mounting holes: M10			
<b>Foot control for DS 200-E and DS 400-E</b>					
				<b>0 200 301-6</b>	
		2-button foot switch Left button: Start/Stop rotation- Right key: Change rotating direction			

## Positioner joke Junior

### Positioner joke Junior

For flexible polishing of smaller workpieces: the ball joint can be rotated in all directions and fixed with a clamping lever. In addition, the magnet can be rotated by 360° and fixed using a clamping lever.

	Order No.	Price from 1 piece
<b>Positioner joke Junior</b>		
Freely rotatable ball joint	<b>0 200 049</b>	
rotation range magnet: 360°		
Magnet dimensions: Ø 125 x 48 mm		
Pivot range: 0–55°		



7

## Ball joint vices JUNIOR

	Design	Order No.	Price from 1 piece
<b>JUNIOR ball joint vices</b>			
JUNIOR ball joint vice with rippled hardened steel jaws. For clamping to worktops up to 75 mm thick.	for clamping	<b>0 200 055</b>	
Jew width: 80 mm	for screwing in position	<b>0 200 056</b>	
Clamping length: 65 mm			
Clamping depth: 50 mm			
Inclination: ± 50°			





# Magnetic clamping ball joke Magic-3D

Clamping magnet with 3 directions of movement in X = 360°, Y = 230°, Z = 230°  
 Fastening of the bracket by integrated 2nd magnet, by 3 screws or 3 pads  
 sphere diameter: 50 mm  
 Clamping surface diameter: 20 mm  
 Positioning force: 16 N  
 weight: only 125 g



	Dimensions	Order No.	Price from 1 piece
<b>Magnetic clamping ball joke Magic 3D</b>	Ø 50 mm	<b>0 200 319</b>	



# Precision grinding and control vices

## Precision machine vice

Ground on all sides for 4-side processing, hardened steel, with prism jaws, draw-down clamping system, accuracy 0.005 mm.

	Jaw widths	Clamping length	Jaw height	Dimensions	Order No.	Price from 1 piece
<b>Precision grinding and control vice</b>						
	48 mm	70 mm	25 mm	50 x 140 mm	<b>0 200 342</b>	
	63 mm	87 mm	32 mm	63 x 175 mm	<b>0 200 343</b>	

Ground on all sides for 4-side processing, hardened steel, with prism jaws, accuracy 0.005 mm.

	Jaw widths	Clamping length	Jaw height	Dimensions	Order No.	Price from 1 piece
<b>Precision machine vice</b>						
	48 mm	65 mm	25 mm	50 x 150 mm	<b>0 200 347</b>	

# Magnetic clamping balls joke Magic-Ball

## Magnetic clamping balls joke Magic-Ball

Comfortable and ergonomic 3-dimensional work. Ideal for polishing and welding workplaces. The Magic-Ball magnetic clamping balls bring your workpiece into almost any desired position. Depending on the workpiece geometry and weight, pivoting angles of up to 90° can be set. The balls are enclosed in leather-lined, chemically nickel-plated steel rings that hold them absolutely securely in any position – the sliding adhesion effect makes it possible! The powerful magnetic chuck of the Magic-Ball is activated using the key supplied (partial activation is also possible for optimum positioning of the workpiece). The balls available in four sizes are all of “Made in Germany” quality.



**i Non-magnetic components are clamped...** using the precision vices also available from us. Fixing of the components upright is therefore also possible.

Further information on page 484

	Dimensions	Clamping force	Pole pitch	Weight	Order No.	Price from 1 piece
<b>Magnetic clamping balls joke Magic-Ball</b>						
	magnet (Ø): 80 mm ball (Ø x H): 128 x 104 mm	80 N/cm <sup>2</sup>	1.5 + 0.5 mm	ball: 4 kg ring: 1 kg	<b>0 200 323</b>	
	magnet (Ø): 100 mm ball (Ø x H): 158 x 129 mm	100 N/cm <sup>2</sup>	1.5 + 0.5 mm	ball: 7 kg ring: 2 kg	<b>0 200 324</b>	
	magnet (Ø): 130 mm ball (Ø x H): 188 x 145 mm	100 N/cm <sup>2</sup>	1.5 + 0.5 mm	ball: 11 kg ring: 4 kg	<b>0 200 325</b>	
	magnet (Ø): 160 mm ball (Ø x H): 218 x 164 mm	100 N/cm <sup>2</sup>	1.5 + 0.5 mm	ball: 17 kg ring: 5 kg	<b>0 200 326</b>	



The magnetic chuck is activated using the key supplied

## Vices

### Rotating and reversible clamp

	Design	Order No.	Price from 1 piece
<b>Rotating and reversible clamp 1 B</b>			
	For clamping to workbenches up to 80 mm thick.	with plastic jaws	<b>0 200 002</b>
	Jaw width: 46 mm		
	Clamping length: 50 mm		
	Clamping depth: 35 mm		

<b>Rotating and reversible clamp 2 B</b>			
	For clamping to workbenches up to 80 mm thick.	with aluminium jaws	<b>0 200 015</b>
	Jaw width: 80 mm		
	Clamping length: 100 mm		
	Clamping depth: 52 mm		

#### Accessories / spare parts

Design	Order No.	Price from 1 set
<b>Replacement jaws for rotating and reversible clamp 1 B</b>		
plastic	<b>0 200 030</b>	
Aluminium	<b>0 200 031</b>	
<b>Replacement jaws for rotating and reversible clamp 2 B</b>		
plastic	<b>0 200 032</b>	
Aluminium	<b>0 200 033</b>	

# Engraving Ball

## unlimited clamping options

### Engraving Ball

This engraving ball has a painted, non-reflecting surface. It provides unlimited clamping options for holding tools securely. It also has holes for mounting additional tools. The upper part has an adjustable brake, which allows it to be either fixated or rotated around its own axis. The ball has a stable seating, but can still be swiveled in all directions. The centrally adjustable, self-centering jaws with prisms also enable round workpieces to be clamped.

Engraving Ball	Dimensions	Order No.	Price from 1 piece
 <p>The engraving ball has a maximum opening of 85 mm. The wide range of accessories includes: upper part with locking brake, including clamping key, 2 mounting plates, rubber pads, 4 pins and a 30-part set of accessories.</p>	Ø 150 mm	<b>0 200 329</b>	



Scope of delivery

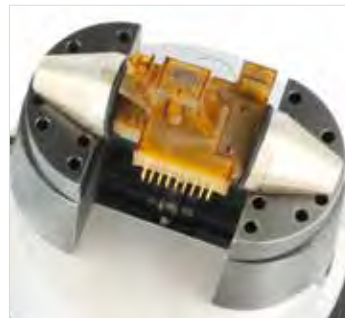

Felt-padded retaining accessory



Mould jaws made of modelling granulate

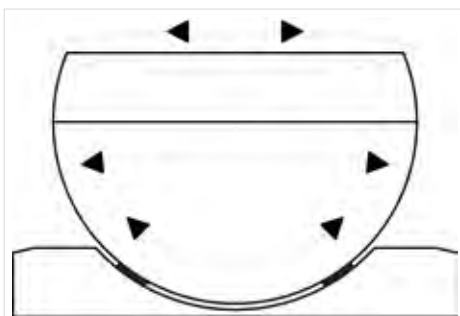

- Ball freely rotatable and pivotable
- Top section rotatable through 360°

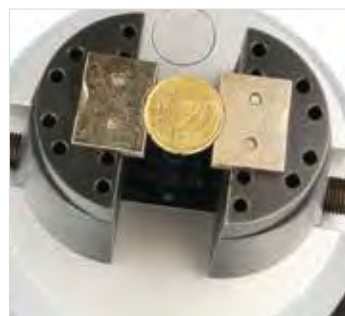

Retaining accessory for flat, round components



Mounting via retaining pins



# Illuminated magnifying glass

## LED illuminated magnifying glass

### LED illuminated magnifying glass

A classic meets high technology. 60 LED's create a fantastically bright light while saving power and have a very long life. 2.25 x magnification can be achieved with the real glass, 5-dioptre magnifying glass. The flexible, 860 mm-long articulated arm rapidly brings the magnifying glass into any desired working position. We have something else for you in addition to all the technical highlights: the price.

Price from

Order No.

1 piece

### LED illuminated magnifying glass



Equipment:	60 LEDs / 800 lm	<b>0 200 575-3</b>
Colour temperature:	6500 K	
Material Head:	plastic	
Articulated arm:	steel tubing	
Articulated arm range:	860 mm	
Lamp cover:	Plastic shade	
Lens dimensions:	Ø 152 mm	
Lens dioptre:	5	
Magnification:	2.25 x	
Connection:	230 V, 50/60 Hz	
Weight:	3.7 kg	



60 LEDs for optimum,  
energy-saving illumination



# Illuminated magnifying glass LED Premium

## Illuminated magnifying glass LED Premium

This illuminated magnifying glass is characterised by several special features

- A wide range of action – even large workpieces can be observed
- A mobile magnifying glass unit – workpieces can be observed from any angle
- energy-saving, energy efficiency class A+
- separately switched LED-light segments cause a 3D shade effect that are focused on their structure, this focus shows small errors and differences in the surface structure of an object
- A distortion-free field of vision allows optimum work under the magnifying glass
- Screw-fit lamp foot
- Ground lens made of optical glass



	Order No.	Price from 1 piece
--	-----------	-----------------------

Illuminated magnifying glass LED Premium		
Equipment:	LED's, energy efficiency class A+	<b>0 200 560-LED</b>
Colour temperature:	4,000 K	
Mains connection cable:	ca. 3 m, earthing plug	
Material:	steel tubing, powder-coated	
Articulated arm range:	700 mm	
Light output:	LED-light segments switchable in multi stages	
Lamp cover:	shade, matt	
Joint relief:	spring	
Pivoting range:	60° / 310°	
Rotation range:	360° magnifying glass	
Protection class:	I	
Protection:	IP 20	
Power input:	about 12 W	
Dimensions of lens:	162 x 105 mm	
Dioptres, lens:	3	
Supply voltage:	220 – 240 V / 50/60 Hz	
Weight:	approx. 4.5 kg	
Colour:	RAL 7035	
Specific features:	light segments can be switched separately, excellent colour reproduction, RA > 95	



### Good to know

#### Diopte

denotes the power of refraction of the lens. This value also determines the ratio between the magnification factor and the focal distance.

#### Focal distance

is the distance between the centre of the magnifying glass and the object observed, at which no distortion occurs.

#### Magnification factor

is the degree of magnification of the object observed.

#### How is the magnification calculated?

The following formula can be used to calculate the magnification factor:

$$\frac{\text{No. of diopte}}{4} + 1 = \text{magnification factor}$$

The illuminated magnifying glass therefore corresponds to a magnification of:

$$\frac{3}{4} + 1 = 1.75$$

#### Some further useful tips:

- The focal length and size of the lens decrease with increasing magnification.
- In order to achieve maximum, distortion-free magnification, hold the magnifying glass approx. 25 cm from your eyes.



### Accessories / spare parts

	Order No.	Price from 1 piece
--	-----------	-----------------------

#### Table clamp



clamping range 0 – 65 mm

**0 200 561**

# Illuminated magnifying glass

## Magic touch

### LED illuminated magnifying glass Magic touch

More light per watt. 63 innovative LEDs ensure optimal light conditions with minimised energy usage. Next advantage: service life of at least 50,000 working hours. That means six years of light non stop without any maintenance costs. The show-stopper is the operation via the touch sensor integrated in the lamp head. A gentle touch is enough to turn the light on and off.

Thanks to the high tech optics, the light is precisely focussed and light loss through scattering is drastically reduced. The plastic lens (Ø 72 mm) has a power of 6 dioptries, which means 2.3x magnification of the viewed objects. The lens has a hard coating to prevent scratches. The highquality lens protection cover shields the lens against damage during work breaks. The lamp can optionally be fixed directly onto the workplace with a plastic foot and four screws, or attached using the table clamp available as an accessory.

	Order No.	Price from
		1 piece

### LED illuminated magnifying lamp Magic touch



Equipment:	63 LEDs	<b>0 200 568</b>
Colour temperature:	4,300 K, neutral white	
Swan neck:	400 / 233 mm (flexible/fixed)	
Lamp service life:	at least 50,000 h	
Dimensions of head/lens:	Ø 122 / Ø 72 mm	
Dioptre lens:	6	
Connection:	100 – 240 V, 50/60 Hz	

7



63 LEDs for as much light per watt

Flexible swan neck for perfect positioning above the material to be tested

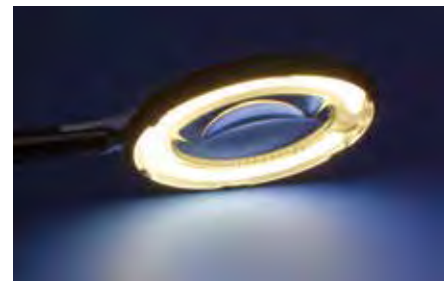

### Accessories / spare parts

	Order No.	Price from
		1 piece

#### Magnetic base Ø 89 mm



Suitable for LED magnifying glass Magic touch (0 200 568)

**0 200 556**

#### Magnetic support plate 90 x 85 mm



Suitable for table clamp (0 200 561)

**0 200 542**

#### Table clamp



clamping range 0 – 65 mm

**0 200 561**

# Innovative workplace lighting SunLike

**NEW!**



The light makes all the difference!  
The light is modelled on the natural spectrum of sunlight, which means it not only offers a better visual effect, but also greater colour fidelity. The LED technology is so bright and lifelike that reflected glare is virtually eliminated and objects look clearer and more starkly contrasted.

	Order No.	Price from 1 piece
--	-----------	-----------------------

<b>SunLike workplace light</b>		
	Special LEDs with daylight-like spectrum Nominal output: 63 W Colour temperature: 4,000 K Lamp service life: approx. 50,000 hours Brightness: dimmable by multifunction switch Dimensions: 900 mm x 122.16 mm x 42 mm Supply voltage: 220 - 240 V(AC), 50/60 Hz Light current: 4,351 lm Illuminance: 1,805 Lux (1 m distance) Degree of protection: IP 30 Operating temperature: 0 to 30°C	<b>0 200 365</b>

### ⚙️ Accessories / spare parts

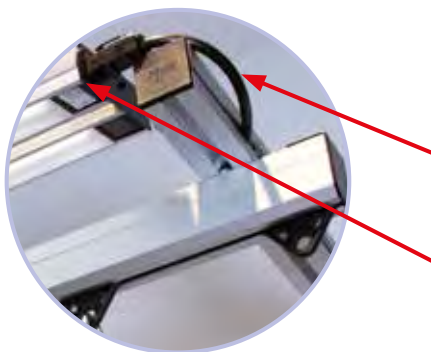



	Order No.	Price from 1 piece
<b>Workplace light connecting lead</b>		<b>0 200 365-2</b>
<b>Workplace light mounting bracket</b>		<b>0 200 365-1</b>

## Workplace light LED version

		Price from
		Order No. 1 piece
<b>LED workplace light</b>		<b>0 200 524</b>
	<ul style="list-style-type: none"> <li>• Flexible light holder tube</li> <li>• 3-stage adjustable</li> <li>• With clamp mounting, max. 45 mm clamping range</li> </ul>	
	Technical data:	
	Equipment:	3-watt LED / 350 lm
	Colour temperature:	5,000 K
Connection:	USB, 5V 1A / 5V 2A input	

## Workplace light LJ1 LED version

		Price from
		Order No. 1 piece
<b>LED workplace light LJ1</b>		<b>0 200 526-7</b>
 	<ul style="list-style-type: none"> <li>• Light beam continuously adjustable from wide beam (36°) to spotlight (10°)</li> <li>• Even places that are difficult to reach can be illuminated</li> <li>• Brighter than a 50 W halogen light with 80 % reduced power consumption</li> <li>• Flexible, plastic-coated, metal light holder tube (700 mm)</li> <li>• Switch integrated in light head</li> <li>• Cooling star and focus made of aluminium (anodised)</li> <li>• Lamp head and housing made of plastic (oilproof, impactproof, non-flammable)</li> </ul>	
	Technical data:	
	Equipment:	3 watt-high-power LEDs
	Colour temperature:	6,000 K
Luminosity:	50,000 lux (spotlight)	
6,000 Lux (wide beam)	10° to 36° infinitely adjustable	
Angle of reflection:	35,000 h	
Bulb life:	110 – 240 V, 50/60 Hz	
Connection:	IP 20	
Protection class:	Lamp incl. plastic table clamp and magnetic base	
Scope of supply:		

### Accessories / spare parts

		Price from
		Order No. 1 piece
<b>Magnetic base Ø 80 mm</b>		<b>0 200 535</b>
	Suitable for workplace light HJ1 (0 200 533), workplace light KJ1 (0 200 534) and LED workplace light LJ1 (0 200 526-7)	



## Workplace light KJ1 Cold light version

 Price from  
1 piece

Order No.

### Workplace light KJ1 – cold light, 11 W



- robust 700 mm metal articulated tube (coated) for free mobility of the lamp head with high positional stability
- fluorescent tube (11 W) for soft, low-shadow and dazzle-free light
- rotatable lamp head

**0 200 534**
**Technical data:**

Equipment:	1 x fluorescent tube, 11 W
Colour temperature:	3,000 K
Luminosity:	1,150 lux
Bulb life:	approx. 8,000 h
Connection:	230 V, 50/60 Hz
Cable length:	3 m with moulded contoured plug
Protection class:	IP 40
Scope of delivery:	lamp incl. plastic table clamp

## Workplace light HJ1 Halogen version

 Price from  
1 piece

Order No.

### Workplace light HJ1 – halogen, 20 W



- robust 600 mm metal articulated tube (coated) for free mobility of the lamp head with high positional stability
- with protective glass cover

**0 200 533**
**Technical data:**

Equipment:	1 x halogen bulb, 20 W
Colour temperature:	2,800 K
Luminosity:	3,850 lux
Angle of reflection:	36°
Bulb life:	approx. 2,000 h
Connection:	230 V, 50/60 Hz
Cable length:	3 m with moulded contoured plug
Protection class:	IP 20 (also available in IP 54!)
Scope of delivery:	lamp incl. plastic table clamp and protective glass cover

Also available as spotlight with 10° beam angle!

## Modeling granules easily applicable

The plastic already becomes soft and ductile at 60 °C. Add the granulate to warm water at max. 65 °C. As soon as the granulate has become completely transparent, it can be removed from the water and shaped with the hand. Once completely cooled, the plastic is hard but not brittle.

		Price from
		Order No. 1 piece
<b>Modeling granules</b>		
Content:	1 kg	<b>0 960 071</b>



Raw granulate



Mould jaws



Mobile phone holder



Moulding



Drilling device



Tool handles

# Precision impression silicone

## Provil Novo Light CD 2

### Precision impression silicone Provil Novo Light CD 2

Work in narrow slots or bore holes is already tricky enough in itself. Yet how can you expect to assess the results if you can hardly see anything during processing? Very simply: with Provil Novo Light CD 2 precision impression silicone.

Behind the somewhat unwieldy name is a very free-flowing silicone that reaches practically everywhere. A precise and fine impression (impression accuracy:  $< 0.1 \mu\text{m}$ ) of even the most difficult geometrical shapes is achieved, even overhead.

The application system guarantees an absolutely constant mixing ratio for safe, error-free use: the silicone is evenly expelled from both chambers of the double cartridge by means of a mixing gun and through the mixing canula and is directly applied to the object. Mixing canula attachments can be used in addition for minute cavities.

#### The advantages at a glance:

- Exact replicas with maximum impression accuracy ( $< 0.1 \mu\text{m}$ )
- Extremely simple use without prior knowledge owing to the application system
- No heat generation during use (therefore no influence on the surface characteristics)
- Limited time expenditure + economical
- No hazardous substances, no health and safety risk





	Order No.	Price from 1 piece
<b>Provil Novo Light CD 2 precision impression silicone</b>		
 2 x double cartridges (50 ml respectively) incl. 12 mixing canulas	<b>0 960 041</b>	

### ↓ matching set



	Order No.	Price from 1 set
<b>Starter set, Provil Novo Light CD 2 precision impression silicone</b>		
2 x silicone incl. mixing gun, mixing canulas (12 pcs.) and attachments (8 pcs.)	<b>0 960 040</b>	

### ⚙ Accessories / spare parts

	Packing quantity	Order No.	Price from 1 piece	1 pack
 <b>Mixing gun</b>				
suitable for Provil Novo Light CD 2 double cartridge		<b>0 960 042</b>		
 <b>Mixing canula attachments (8 pieces)</b>				
narrow/curved, for filling very fine slots	8 pieces	<b>0 960 043</b>		
 <b>Replacement mixing canulas (12 pieces)</b>				
Replacement mixing canulas for Provil Novo Light CD 2 double cartridge	12 pieces	<b>0 960 044</b>		

## Cutting oils and pastes, separating agents and sprays

### Thread cutting paste Solis Pina V4G

- The paste for extremely difficult working processes in which liquid oils do not provide any satisfactory results
- Chlorine-free and odourless
- Excellent for drilling, thread cutting, reaming, groove broaching, tapping, turning and milling
- For rust-free and heat-resistant alloys, molybdenum, manganese, chrome nickel steel, VA and titanium



	Content	Order No.	Price from 1 piece
<b>Thread cutting paste Solis Pina V4G</b>			
	750 g can	<b>0 960 403</b>	

### Cutting oil foam Solis Ambo N4G

- Foam with very good adhesive properties for economical processing
- Mineral oil-free, chlorine-free, skin-friendly
- Excellent for drilling, thread cutting, reaming, groove broaching, tapping, turning and milling
- For all alloyed and non-alloyed steels, chrome nickel, titanium, manganese, copper and its alloys



	Content	Order No.	Price from 1 piece
<b>Cutting oil foam Solis Ambo N4G</b>			
	400 ml aerosol	<b>0 960 401</b>	

### High performance cutting oil Solis Ambo M5S

- Increased viscosity for difficult machining tasks
- Chlorine-free
- Excellent for drilling, thread cutting, reaming, groove broaching, tapping, turning and milling
- For all alloyed and non-alloyed steels, chrome nickel, titanium, manganese, copper and its alloys



	Content	Order No.	Price from 1 piece
<b>High performance cutting oil Solis Ambo M5S</b>			
	500 ml spray bottle	<b>0 960 402</b>	

## Cutting oils and pastes, separating agents and sprays

### Universal oil BALLISTOL

Uniquely versatile and environment-friendly at the same time. This oil cares, lubricates, disinfects, protects against rust, creeps into the minutest corners, has a very low friction coefficient and does not resinify. With all these superb qualities, the oil is fully biodegradable, food-grade, skin-friendly and completely harmless. Use in industry, trade, hobby and soon with you too.



	Content	Order No.	Price from 1 piece
<b>Universal oil BALLISTOL</b>			
	200 ml aerosol	<b>0 960 601</b>	

### Universal cleaner Luxan Clean Uni

- Highly concentrated water-based cleaner
- Dilutable up to 1:40
- Dissolves heavy soiling in seconds
- For removing oil, grease and protein soiling
- For machines and surfaces made of metal, plastic, ceramic and many more



	Content	Order No.	Price from 1 piece
<b>Universal cleaner Luxan Clean Uni</b>			
	500 ml hand sprayer	<b>0 960 404</b>	

## Spray bottles for decanting cleaners and other liquids

### Spray bottles

for transferring cleaners and other liquids from large containers. Particularly suitable for diamond fluids or lapping fluids such as diamond suspensions soluble in oil or water.



	Order No.	Price from 1 piece
<b>Pump spray bottle, 250 ml</b>		
	<b>0 580 455</b>	
<b>Spray bottle, 100 ml</b>		
	<b>0 580 515-2</b>	



## Compressed air spray can refillable



### Compressed air aerosol

Using this refillable aerosol, most liquid materials can be processed (ideal for spray-on oils, cleaners or cooling lubricants). This saves you a good deal of packaging waste and various different active substances can be economically refilled from large containers. Handling is child's play: the material is filled into the aerosol from above and charging with compressed air is performed through the base valve by means of the matching compressed air service station (optimum operating pressure 5–10 bars). Only the pure active ingredient and no compressed air is sprayed during use!

	Order No.	Price from 1 piece
<b>Compressed air spray can</b>		
Filling quantity: 400 ml, refillable from above, compressed-air filling viabase valve and the matching compressed-air service station, supplied incl. 2 valves and 4 spray heads	<b>0 960 610</b>	



### Accessories / spare parts

	Order No.	Price from 1 piece	1 set
<b>Compressed-air service station</b>			
 for direct connection to the compressed-air network by means of a push-fit nipple, hose length approx. 0.5 m. For filling, the compressed-air aerosol is pushed into the service station. After the filling operation (approx. 8–10 seconds), the valve closes automatically. The service station can remain on the compressed-air network.	<b>0 960 611</b>		
<b>Spray head valve set</b>			
 consisting of four different spray heads and a ball valve with a suction tube	<b>0 960 615</b>		

# Sprays

## Cleaning fluid X 73016-A

For all metals, glass, ceramic and many plastics. Use: cleaning moulds, cleaning machine components, pretreatment of glue points, pretreatment for lacquering. The spray cleaner rapidly evaporates and works without leaving residues. Unlike during use of solvent, no residual layer is left behind. Even removes resinated lubricants. Thermoplastics such as PVC, Plexiglas, polystyrene and simple paint strokes can be dissolved.

	Content	Order No.	Price from		
			1 piece	12 pieces	5 pieces
<b>Cleaning fluid X 73016-A</b>					
	500 ml aerosol	<b>0 580 521</b>			
	5 l container	<b>0 580 522</b>			
	28 l container	<b>0 580 523-1</b>			



## Double nozzle suitable for many spray cans

	Order No.	Price from
		1 piece
<b>Double nozzle</b>		
Multifunctional spray head for exact dosage in hard-to-reach places or even application through mist spray nozzle	<b>0 580 538</b>	



Even application due to mist spray nozzle

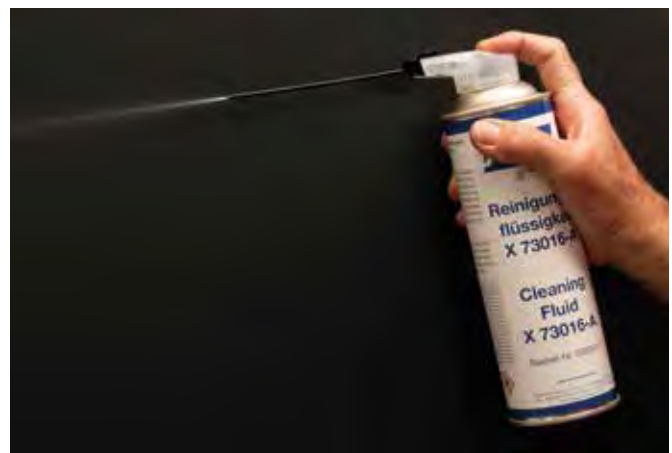

Punctual, targeted application due to spray jet nozzle

## Sprays

### Cleaning fluid X 73020

Finds applications in industry and workshop areas. Owing to its special formula, the spray combines corrosion protection, cleaning, water repellence, lubrication and preservation in a single product. The spray dissolves rust, repels moisture, eliminates squeaking noises, cleans soiled surfaces, protects and cares for all tools and can also do farmuch more. A genuine all-round performer that no workplace should be without.

	Content	Order No.	Price from	
			1 piece	12 pieces
<b>Cleaning fluid joke X 73020</b>				
	400 ml aerosol	<b>0 580 526</b>		



### Corrosion protection X 73030

With a composition based on synthetic wax and special additives, this spray offers both temporary corrosion protection and preservation of uncoated bright metals. Adheres to all metal surfaces, leaving behind a tacky, flexible protective film, free of silicone or silicone-based products. Seawater-resistant and therefore also suitable for corrosion protection during shipping by sea for example. Ideal for preserving stock items (injection moulds, etc.) and precision components, tools, etc.

	Content	Order No.	Price from	
			1 piece	12 pieces
<b>Corrosion protection X 73030</b>				
	400 ml aerosol	<b>0 580 525</b>		



# Sprays

## Aluminium grinding spray X 73050

The low degree of hardness of aluminium and other non-ferrous metals can lead to clogging of the pores of the processing tool. The simple use of this aluminium grinding spray prevents this and leads to improved stock removal (by up to 350 %!). At the same time, the spray cools the material and reduces the shearing forces during processing. Suitable for use with all grinding media on a base, such as abrasive discs, sleeves, strips etc.

	Content	Order No.	Price from	
			1 piece	12 pieces
<b>Aluminium grinding spray X 73050</b>	400 ml aerosol	<b>0 580 529</b>		



## Diamond compound cleaner joke Magic

This cleaner which is universally usable for all diamond compounds cleans the workpieces without leaving streaks after polishing. Can also be used for cleaning lapped workpieces. The spray is oil and silicone-free and therefore has a very discreet odour. Simple handling with simultaneously high cleaning power make the cleaner indispensable for any polisher.

	Content	Order No.	Price from	
			1 piece	12 pieces
<b>Diamond compound cleaner joke Magic</b>	500 ml aerosol	<b>0 590 610</b>		



## Protection for the lungs

### Fine dust masks

#### Fine dust masks

Professional protection against solid and liquid particles, fine dusts and even smog. High quality valve technology ensures a fresh climate under the mask, since warm, moist expired air is vented to the exterior.

The innovative filtering allows on the one hand greater protection and at the same time facilitates breathing when the mask is applied. The masks are comfortably and safely positioned owing to the preformed mask bodies and the flexible nose pads. The FFP3 model is equipped with a foam sealing lip and therefore sits even more comfortably and tightly in place. Additional protection provided by activated charcoal against organic gases and acid vapours.

#### Application areas:

- FFP2 up to 10 times the MAK limit value
- FFP3 up to 30 times the MAK limit value

	Packing quantity	Order No.	Price from 1 piece
<b>Fine dust mask FFP2 with expiration valve</b>	10 pieces	<b>0 960 720-0</b>	
			
<b>Professional fine dust mask FFP3 with expiration valve</b>	5 pieces	<b>0 960 722</b>	
			

## Protection for the eyes

#### Protective goggles

- Clear, optically correct, single-piece PC pane
- Scratchproof coating
- Casual design, extremely light (21.5 g)
- Protection against general hazards and flying particles (up to 45 m/sec.)
- Comfort pads on the temple ends
- Soft nose pad

	Order No.	Price from 1 piece
<b>Protective goggles</b>	<b>0 203 083-1</b>	
		



# Protection for the eyes

## Protective goggles with progressive lenses

### Protective goggles JK 16 with progressive lenses

Finally a pair of protective goggles with progressive lenses – that is what the JK 16 from joke offers, making them a good alternative to the “second pair of spectacles” for age-related long-sightedness.

The JK 16 is available in 6 strengths for optimum compensation of visual impairment. With 1.0 to 3.5 dioptres, the spectacles offer maximum wearing comfort coupled with optimum protection.

#### Special features:

- Progressive lenses certified according to EN166 FT.
- Closed side protection with ventilation slots and treatment of the lenses with an antifog coating permanently guarantee a clear view.
- The temples are variable in angle and adjustable in length for optimum wearing comfort.
- These protective goggles weigh a mere 44 g for a strength of +2.5 dioptres and offer overall the optimum prerequisites for fatigue-free work.

#### Scope of delivery:

- Microfibre case
- Spectacle cord (according to EN166)

	Maximum correction in the bottom part of the lenses	Moderate correction in the centre of the lenses	Minimal correction in the top part of the lenses	Order No.	Price from 1 piece
<b>Protective goggles JK 16 with progressive lenses</b>					
	1.0 dioptres	1.0 dioptres	0.3 dioptres	<b>0 960 750</b>	
	1.5 dioptres	1.2 dioptres	0.7 dioptres	<b>0 960 751</b>	
	2.0 dioptres	1.4 dioptres	0.7 dioptres	<b>0 960 752</b>	
	2.5 dioptres	1.9 dioptres	1.2 dioptres	<b>0 960 753</b>	
	3.0 dioptres	2.3 dioptres	1.4 dioptres	<b>0 960 754</b>	
	3.5 dioptres	2.8 dioptres	1.9 dioptres	<b>0 960 755</b>	





# Hand protection

## Nitrile disposable gloves

Non-powdered gloves in a practical dispensing box (contains 100). Both materials offer extremely good sense of touch combined with flexibility and wearing comfort. The nitrile gloves are not only antiallergic, but also markedly more robust (puncture and tear-resistant) than those made of latex. They furthermore offer protection against solvents, bacteria, paints, alkalis, acids, oils, greases and many chemicals.  
Length 24 cm

	Size	Packing quantity	Order No.	Price from 1 pack
<b>Nitrile disposable gloves</b>				
	L	100 pieces	<b>0 960 706</b>	
	XL	100 pieces	<b>0 960 707</b>	



	Size	Packing quantity	Order No.	Price from 1 pairs
<b>Maxi-Hit all-round gloves</b>				
	7	12 pairs	<b>0 960 701-7</b>	
	8	12 pairs	<b>0 960 701-8</b>	
	9	12 pairs	<b>0 960 701-9</b>	
	10	12 pairs	<b>0 960 701</b>	



### Maxi-Hit all-round gloves

- Nitrile Foam Technology (NFT) makes these gloves an "all-rounder":
- Abrasion-resistant, pleasant, flexible and breathable
- Liquid repellent
- Hard wearing and sensitive
- Back of hand made of Spandex liner for high stretchability and rapid drying

Material, LINER: 96 % nylon, 4 % elastane with (NFT) nitrile coating

# Hand protection

	Size	Packing quantity	Order No.	Price from 1 pairs
<b>Ultra Lite PU Hyflex gloves</b>				
	8	12 pairs	<b>0 960 702-8</b>	
	9	12 pairs	<b>0 960 702-9</b>	
	10	12 pairs	<b>0 960 702</b>	

### Ultra Lite PU Hyflex gloves

- Hard wearing fine knitted nylon with supersoft PU coating
- Maximum wearing comfort and sense of touch
- Lint-free and breathable
- Super sensitive and highly flexible
- Exact fit and adaptability
- No fingerprints
- Several times reusable

Material, LINER: 100 % nylon with PU coating

	Size	Packing quantity	Order No.	Price from 1 pairs
<b>Gloves with PU fingertips</b>				
	10	12 pairs	<b>0 960 703</b>	

### Gloves with PU fingertips

- Fingertips with PU coating on fine nylon liner
- Pleasant to wear
- Grip only in the fingertips
- Exact fit
- Lint-free
- Welded in pairs

Material, LINER: 100 % nylon with PU coating

	Size	Packing quantity	Order No.	Price from 1 pairs
<b>Nubbed thermal assembly gloves</b>				
	9	12 pairs	<b>0 960 705</b>	
	10	12 pairs	<b>0 960 705-10</b>	

### Nubbed thermal assembly gloves

- Heat-resistant up to 150 °C
- Abrasion-resistant, sensitive, breathable
- Highly adaptable fit owing to stretchability

Material, LINER: 100 % polyacryl liner with foam nitrile

## Rotating tool holder brings tidiness to your workplace

			Price from
			1 piece
Order No.			
<b>Rotating tool holder</b>			
	Rotating tool holder from joke: everything within easy reach		<b>0 200 020</b>
	<p>Every desired tool is always at hand. Eliminates tiresome searching for the right implement. The rotating tool holder allows accommodation of more than 100 tool units. All the essential utensils for surface finishing (or other working stages) are in one place.</p> <p>The following items are available overall:</p> <ul style="list-style-type: none"> <li>• 92 receptacles for tools with a Ø 3 mm or 1/8" shank</li> <li>• 13 receptacles for tools with a Ø 6 mm or 1/4" shank</li> <li>• 7 receptacles for different drills</li> <li>• internal receptacle for tools, Ø 70 x 75 mm deep</li> <li>• Dimensions: Ø 165 mm x 102 mm</li> </ul>		



## Surface protection

### Surface protection film

The simplest way of protecting scratch and dirt-sensitive surfaces during further processing, transport or storage. This film is fixed to the workpiece like an adhesive tape and can be detached again, above all absolutely without leaving residues. Suitable for steel, copper, anodised aluminium and glass, etc. Heat-resistant between -20 °C and +60 °C.

					Price from
					1 piece
Width	Total length	Thickness	Order No.		
<b>Surface protection film</b>					
250 mm	100 m	50 µm	<b>0 960 380</b>		

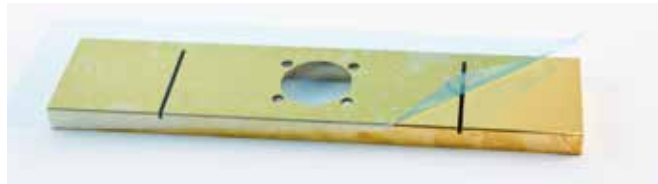

## Waste bags

				Price from
				1 piece
Capacity	Content	Order No.		
<b>Waste bags</b>				
70 l	1 roll (25 bags)	<b>0 960 458</b>		
120 l	1 roll (25 bags)	<b>0 960 459</b>		

### Waste bags

- Extra strong and tear-resistant
- draw-string
- Two sizes (70 and 120 litres)



# Industrial paper

## Industrial paper

This high-quality blue paper towelling absorbs almost anything, particularly readily and effectively dirt, oils and greases ... highly absorbent and tear-resistant. Supplied on a roll of 1,000 sheets (roll length 360 m). Matching floor stands and wall holders as accessories.

		Order No.	Price from 1 piece
<b>Industrial paper roll, 3-layer</b>			
	Cleaning cloth rolls • embossed and glued • firm quality • highly absorbent • recycled material	<b>0 960 450</b>	
	1 roll of 1,000 sheets (360 x 360 mm each), roll length: 360 m		

# Universal liquid-absorbent mat

## Universal liquid-absorbent mat

It mops everything up. Your workplace should no longer be without this mat if you work with oils, lubricants and chemicals. In this way, you can simply and effectively protect floors and working surfaces for example during cleaning, machine repairs and lining tool drawers, etc.

The highly absorbent mat can absorb a tidy 0.86 litres per cloth. It consists of polypropylene and fine fibre layers; a PE film on the back protects against soaking through. Important: the mats are absolutely lint-free.

Application areas: workshops, laboratories, hobby (car, motorcycle), household (oil heating, lawnmower, chainsaw ...).

			Order No.	Price from 1 pack
Dimensions	Packing quantity			
<b>Universal liquid-absorbent mat</b>	430 x 480 mm	10 piece	<b>0 960 500</b>	



Machine leaks



Use of sprays



Ultrasonic cleaning



## Polishing wool

If it is good for human skin, it cannot fail to be right for technical surfaces. Cotton wool is a universal cleaning aid. A choice between cotton and viscose (rayon) in addition to a "50/50 blend" of both is available. Rayon very rapidly absorbs liquid, whereas cotton stores it longer and offers better cohesion of the fibres. Cotton wool pads (100 % cotton) are available in addition to the loose cotton wool balls.

	Design	Material	Content	Packing quantity	Order No.	Price from 1 pack
<b>Polishing wool</b>						
	Cotton wool	50 % viscose / 50 % cotton	100 g in the bag		<b>0 960 010</b>	
		100 % cotton	100 g in the bag		<b>0 960 011</b>	
		100 % viscose	1000 g in the bag		<b>0 960 013-5</b>	
	Cotton wool pads	100 % cotton	40 pieces in the bag	40 pieces	<b>0 960 015</b>	

## Polishing cloths Kleenex

High quality 3-ply cloth for wiping after polishing and for applying joke Magic very fine polishing suspension (similar illustration).

	Design	Content	Colour	Dimensions	Order No.	Price from 1 piece
<b>Polishing cloths Kleenex</b>						
	3 layers	72 cloths	white	20 x 20 cm	<b>0 590 602</b>	



## Cleaning stick



The lint-free cleaning sticks are highly absorbent and owing to their pointed shape, ideal for use in model and mould making as well as in areas such as optics, laser and microtechnology. The rods have a very dense and firm head made of highest-quality cotton. They are therefore super absorbent, suitable for solvents and retain their shape when wet. Perfect for all cleaning tasks in hard-to-reach areas or for precise application of liquids (e. g. adhesives, resins, alcohols).

		Packing quantity	Order No.	Price from 1 pack
<b>Cleaning stick</b>				
	Sharp head on both sides, Ø 5 x 13 mm, hard, head and stick made of cotton	100 pieces	<b>0 960 003</b>	
	Sharp head on both sides, Ø 2.2 x 8 mm, hard, head and stick made of cotton	25 pieces	<b>0 960 081</b>	



## Cleaning wires

Flexible and firm at the same time. Particularly suitable for detaching and removing simple soiling in the drilling holes. Trimming made of soft cotton, with and without incorporated bristles (for maximum cleaning power). The wires are resistant against cleaning media and can be used both wet and dry. Available in long (150 mm) and longer (300 mm), conically wound respectively.

	Material	Dimensions	Packing quantity	Order No.	Price from 1 pack
<b>Cleaning wires</b>					
	Cotton wool without bristles	Ø 4/5 x 150 mm	80 pieces	<b>0 960 005</b>	
	Cotton wool with bristles	Ø 4/5 x 150 mm	80 pieces	<b>0 960 006</b>	
		Ø 3.5/5.5 x 300 mm	50 pieces	<b>0 960 007</b>	



Cotton wool without bristles



Cotton wool with bristles

## Cotton buds

Familiar in principle to any child. The joke cotton buds have a very dense and firm cotton wool head trimming (small and large version available). With their long wooden shanks, they are markedly superior to PP sticks, since more rigid and resistant to cleaners. Furthermore, their diameter also fits in the collets of our handpieces. Use wet or dry for cleaning and with compound for polishing.



	Design	Dimensions	Packing quantity	Order No.	Price from 1 pack
<b>Cotton buds on wooden sticks</b>					
	small head (Ø approx. 4 – 5.5 mm)	Ø 2.3 x 150 mm	100 pieces	<b>0 960 001</b>	
	large head (Ø approx. 10 – 12 mm)	Ø 3 x 200 mm	50 pieces	<b>0 960 002</b>	

## Hand cleansing cloths

For mobile hand cleansing; also for cleaning tools and surfaces, without aggressive solvents and alcohol.

- Highly efficient
- effective cleaning of contamination by oils, lubricating greases, wet paints, adhesive, ink, petrol, etc.
- Simple to use, ideal when out and about and wherever no water is available.
- Large cloths (25 cm x 25 cm) in a resealable bucket
- Provided with an abrasive cloth side for improved cleaning performance.



	Content	Order No.	Price from 1 piece	5 pieces
<b>Hand cleansing cloths</b>				
	70 cloths	<b>0 960 735</b>		



## Precision gauge tapes

### individual and as assortments with sheet sections

#### Precision gauge tapes and reference sheets

The precision gauge tapes and reference sheets are used for example when dressing moulds and tools, compensating tolerances and readjusting the bearing play of guides and cutting blades, adjustment of devices, etc., etc.

The tapes are supplied in hardened springband steel (material no. 1.1274) or Cr-Ni steel.

In addition to this standard selection, we supply you on request and at short notice tapes and cut sections in widths of up to 300 mm made of different materials such as C steel, stainless Cr-Ni steel and brass.

	Thickness	Width	Total length	Material	Order No.	Price from 1 piece
<b>Precision gauge tape</b>						
	0.005 mm	12.7 mm	5 m	1.4310	<b>0 960 300</b>	
	0.01 mm	12.7 mm	5 m	1.4310	<b>0 960 301</b>	
	0.02 mm	12.7 mm	5 m	1.4310	<b>0 960 302</b>	
	0.03 mm	12.7 mm	5 m	1.1274	<b>0 960 303</b>	
	0.04 mm	12.7 mm	5 m	1.1274	<b>0 960 304</b>	
	0.05 mm	12.7 mm	5 m	1.1274	<b>0 960 305</b>	
	0.06 mm	12.7 mm	5 m	1.1274	<b>0 960 306</b>	
	0.07 mm	12.7 mm	5 m	1.1274	<b>0 960 307</b>	
	0.08 mm	12.7 mm	5 m	1.1274	<b>0 960 308</b>	
	0.09 mm	12.7 mm	5 m	1.1274	<b>0 960 309</b>	
	0.10 mm	12.7 mm	5 m	1.1274	<b>0 960 310</b>	
	0.12 mm	12.7 mm	5 m	1.1274	<b>0 960 311</b>	
	0.15 mm	12.7 mm	5 m	1.1274	<b>0 960 312</b>	
	0.20 mm	12.7 mm	5 m	1.1274	<b>0 960 314</b>	
	0.25 mm	12.7 mm	5 m	1.1274	<b>0 960 315</b>	
	0.30 mm	12.7 mm	5 m	1.1274	<b>0 960 316</b>	
0.40 mm	12.7 mm	5 m	1.1274	<b>0 960 318</b>		
0.45 mm	12.7 mm	5 m	1.1274	<b>0 960 319</b>		
0.50 mm	12.7 mm	5 m	1.1274	<b>0 960 320</b>		



## Precision gauge tapes individual and as assortments with sheet sections

	Thickness	Width	Total length	Material	Packing quantity	Order No.	Price from 1 pack
<b>Precision underlay foils</b>							
	0.01 mm	50 mm	300 mm	1.4310	10 pieces	<b>0 960 291</b>	
	0.02 mm	50 mm	300 mm	1.4310	10 pieces	<b>0 960 386</b>	
	0.03 mm	50 mm	300 mm	1.1274	10 pieces	<b>0 960 357</b>	
	0.04 mm	50 mm	300 mm	1.4310	10 pieces	<b>0 960 290</b>	
	0.05 mm	50 mm	300 mm	1.4310	10 pieces	<b>0 960 387</b>	
	0.07 mm	50 mm	300 mm	1.1274	10 pieces	<b>0 960 266</b>	
	0.08 mm	50 mm	300 mm	1.1274	10 pieces	<b>0 960 388</b>	
	0.09 mm	50 mm	300 mm	1.1274	10 pieces	<b>0 960 265</b>	
	0.1 mm	50 mm	300 mm	1.4310	10 pieces	<b>0 960 389</b>	
	1.0 mm	50 mm	300 mm	1.1274	10 pieces	<b>0 960 264</b>	

### matching set



	Order No.	Price from 1 set
<b>Reference sheet assortment, sheets 25 x 300 mm, contents: 21 pieces</b>		
Contains 1 sheet each in the following thicknesses (in mm): 0.01 / 0.02 / 0.03 / 0.04 / 0.05 / 0.06 / 0.07 / 0.08 / 0.09 / 0.10 / 0.15 / 0.20 / 0.25 / 0.30 / 0.40 / 0.50 / 0.60 / 0.70 / 0.80 / 0.90 / 1.00	<b>0 960 330</b>	
<b>Reference sheet assortment, sheets 50 x 300 mm, contents: 25 pieces</b>		
Contains 1 sheet each in the following thicknesses (in mm): 0.01 / 0.02 / 0.03 / 0.04 / 0.05 / 0.06 / 0.07 / 0.08 / 0.09 / 0.10 / 0.12 / 0.15 / 0.18 / 0.20 / 0.25 / 0.30 / 0.35 / 0.40 / 0.45 / 0.50 / 0.60 / 0.70 / 0.80 / 0.90 / 1.00	<b>0 960 331</b>	

### Accessories / spare parts



	Order No.	Price from 1 piece
<b>Tin snips, straight (1 piece)</b>		
for cutting thin sheeting Length: 170 mm cutting edge length: 50 mm	<b>0 960 326</b>	

# Assortment case

## Raaco boxxser

### Raaco boxxser assortment case

This handy case with a carrying handle and clever one-hand locking system can be divided using differently sized inserts. The inserts can be purchased individually or in six different set combinations. A grid in the lid and base of the case prevents the inserts from slipping.

Set A

S1	S1	S1	S1	S1
S2		S5	S5	S5
S2				
S4				S5
S4				

Set B

S1	S1	S1	S1	S1
S6	S6	S6	S6	S6

Set C

S2	S3
S2	S3
S2	S3
S2	S3
S2	S3

Set D

S1	S1	S3
S1	S1	S3
S1	S1	S3
S1	S1	S3
S2		S3
S2		S3

Set E

S1	S1	S3
S1	S1	S3
S1	S1	S3
S1	S1	S3
S1	S1	S3
S1	S1	S3

Set F

S1	S4
S5	S4
S5	S4
S5	S4
S5	S4

	Order No.	Price from
<b>Assortment case</b>		1 piece
	<b>0 960 200</b>	

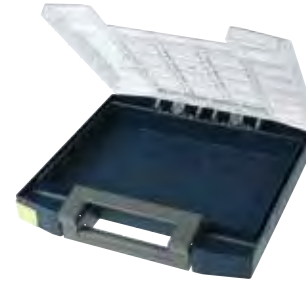

### Case inserts set (without case!)

	Type	Packing quantity	Order No.	Price from
Case inserts set				1 set
	5 x S1, 2 x S2, 2 x S4, 4 x S5	A	13 pieces	<b>0 960 230</b>
	5 x S1, 5 x S6	B	10 pieces	<b>0 960 231</b>
	5 x S2, 5 x S3	C	10 pieces	<b>0 960 232</b>
	6 x S1, 2 x S2, 5 x S3	D	13 pieces	<b>0 960 233</b>
	10 x S1, 5 x S3	E	15 pieces	<b>0 960 234</b>
	1 x S1, 5 x S4, 2 x S5	F	7 pieces	<b>0 960 235</b>

# Assortment case Raaco boxxser

## ⚙️ Accessories / spare parts

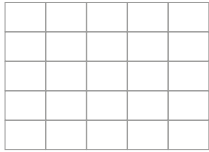

The case can be subdivided internally with inserts by means of a grid system (5 x 5 fields). Each grid has a dimension of 39 x 54 mm (D x W).

### Overall internal case dimensions:

Depth: 5 x 39 mm (195 mm)  
Width: 5 x 54 mm (270 mm)

	Type	Dimensions	Order No.	Price from 1 piece
	<b>Case inserts</b>			
	S1	47 x 54 x 39 mm	<b>0 960 221</b>	
	S2	47 x 108 x 39 mm	<b>0 960 222</b>	
	S3	47 x 162 x 39 mm	<b>0 960 223</b>	
	S4	47 x 216 x 39 mm	<b>0 960 224</b>	
	S5	47 x 54 x 78 mm	<b>0 960 225</b>	
	S6	47 x 54 x 156 mm	<b>0 960 226</b>	



Illustration incl. optional inserts

**Hard-wearing:** the assortment case can take some punishment

# Suction units

## joke Suction units

... Laser emissions, dust and fine particles, solvents, adhesive vapour, solder vapour/ welding vapour ...

at least one of these or some other pollutions also occur daily in your working environment. You should do something about them in order to avoid damage to health.

With a suction unit from joke, you create the optimum conditions for "good air" at the workplace – even if you ever "let it fly".

With us, you have a choice between two suction systems:

- **JF Compact** with favourably priced entrylevel products
- **JFD Premium** as a highly efficient system with comprehensive equipment details (high filter capacity, filter monitoring, serial interface for remote control)

Both systems can be configured with two filter modules. Suspended matter filter for dusts/fine particles and all particles that arise in mechanical processing sequences.

The activated charcoal filter is used wherever solvents, adhesive vapours, soldering vapour, smoke and similar gaseous pollutions arise. It eliminates or reduces them to a minimum.

Owing to the high density of the filters used, a very high level of separation of the particles and contaminants to be aspirated is achieved. The filters can be combined as individual modules and are easy to replace. Consequently, if replacement is required, you only actually need to change the saturated filter, whereas the remainder can continue to be used.

The turbine cooling (bypass cooling) inside the devices ensures very long services lives of the turbine units, even during constant use. The modular construction allows effective adaptation to individual requirements.

### Suction arm for mounting on device

**JF 5 Compact**  
Order No. 0 200 185

**JF 10 Compact**  
Order No. 0 200 242-3

**JFD Premium**  
Order No. 0 200 266

**Suction hood**  
Order No. 0 200 248

**Suction tube**  
Order No. 0 200 243



**Suction arm for table mounting**  
Order No. 0 200 268

**Suction unit**  
**JF 5 Compact**  
Order No. 0 200 225  
**JF 10 Compact**  
Order No. 0 200 230-3  
**JFD Premium**  
Order No. 0 200 250-1



### Things to know about contaminants at the workplace and use of suction units

Aerolsols consist of a large number of dust and smoke particles of different diameters. They occur during production processes such as milling, drilling, laser work, cutting, soldering and engraving, etc. The particle size is indicated in micrometres ( $\mu\text{m} = 10^{-6}\text{m}$ ). Contamination of the respiratory tracts depending on the particle size is shown in the diagram opposite.

#### Maintenance intervals of the filters

With a properly dimensioned unit, the following intervals result for the individual filter types, depending on the contamination:

- Z-line filter: 4 – 8 months
- suspended matter filters: 4 – 8 months
- activated charcoal filters: 6 – 12 months

**Without a change of filter, no protection of your health exists!**

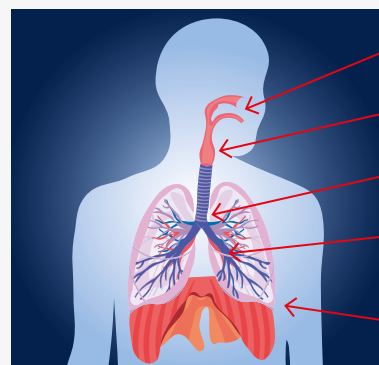

Nasal mucosa and pharynx 10  $\mu\text{m}$

Larynx 4.7 – 5.8  $\mu\text{m}$

Trachea and main bronchi 3.3 – 4.7  $\mu\text{m}$

Secondary and terminal bronchi 1.1 – 3.3  $\mu\text{m}$



Alveoli 1  $\mu\text{m}$

Designed by Alvaro\_cabrera/Freeepik







# Suction units

## joke JFD Premium

	Design	Order No.	Price from 1 piece
<b>Suction unit joke JFD Premium</b>			
	Suction device with initial filter equipment and filter monitoring, continuously adjustable, operating hour counter, 4 castors for mobile use, without accessories	with suspended matter filter	<b>0 200 250-1</b>
	System with W3 certification and HEPA H13 filter	with activated charcoal filter	<b>0 200 250-ZA</b>
Technical data: Suction capacity, free-blowing: 320 m <sup>3</sup> /h Suction capacity, effective: 50 – 250 m <sup>3</sup> /h Max. compression: 20,000 Pa Motor: constant running Connection: 100 – 240 V, 50/60 Hz Motor output: 1.1 kW Noise level: approx. 62 dB(A) Weight: approx. 40 kg (0200 250-1) approx. 55 kg (0 200 250-ZA)			
Dimensions (W x H x D): 350 x 785 x 350 mm (with activated charcoal filter) Colour: RAL 7035 Suction connectors: 3 (rear) Suction connectors for arm: 1 (top)			
Filter equipment: (Order No. 0 200 250-1)		Suspended matter filter H 13 2.4 m <sup>2</sup> + z-line filter	
(Order No. 0 200 250-ZA)		activated charcoal filter + suspended matter filter + z-line filter	
			



### Accessories / spare parts

	Order No.	Price from 1 piece
<b>Suspended matter filter, 300 x 300 x 78 mm</b> 	<b>0 200 246</b>	
<b>Z-line filter, 300 x 300 x 145 mm</b> for units built before 2017 	<b>0 200 245-N</b>	
<b>Z-line-filter plus, 300 x 300 x 225 mm</b> for units built after 2017	<b>0 200 245-3</b>	
<b>Activated charcoal filter, 295 x 295 x 20 mm</b> 	<b>0 200 240-1</b>	
<b>Suction arm for mounting on device</b> 	850 mm long, 3 articulations, with damper cap, anodised aluminium tubes	<b>0 200 266</b>







# Suction units

## joke JF 10 Compact



		Design	Order No.	Price from 1 piece
<b>Suction unit joke JF 10 Compact</b>				
	Suction device with initial filter equipment, infinitely adjustable, operating hour counter, 4 castors for mobile use, not including accessories	with suspended matter filter	<b>0 200 230-3</b>	
		with activated charcoal filter	<b>0 200 230-ZA1</b>	
	<b>Technical data:</b> Suction output, free blowing: 250 m <sup>3</sup> /h Effective suction output: 20 – 200 m <sup>3</sup> /h Max. compression: 6,000 Pa Motor: continuous running Connection: 120 – 230 V, 50/60 Hz Motor output: 0.65 kW Sound level: approx. < 62 dB(A) Weight: approx. 24 kg Dimensions (W x H x D): 300 x 510 x 300 mm Colour: RAL 7035 Suction connectors: 2 (rear) Suction connector for arm: 1 (top)			
	Filter (0 200 230-3): Prefilter F5 + suspended particle filter H 13 Filter (0 200 230-ZA1): Prefilter F5 + suspended particle filter H 13 + activated charcoal filter			

### Accessories / spare parts



		Order No.	Price from 1 piece
<b>Suspended matter filter H 13, 250 x 250 x 190 mm</b>		<b>0 200 271</b>	
			
<b>Filter mats F5, 230 x 230 mm (pack: 20 pieces)</b>		<b>0 200 257</b>	
			
<b>Combination filter suspended matter/activated charcoal, 250 x 250 x 190 mm</b>		<b>0 200 240-4</b>	
			
<b>Suction arm for mounting on device</b>		<b>0 200 242-3</b>	
			

# Suction units

## joke JF 5 Compact

	Design	Order No.	Price from 1 piece
<b>Suction unit joke JF 5 Compact</b>			
 	Suction device with initial filter equipment, continuously adjustable, operating hour counter, 4 device feet, without accessories	with combined filter	<b>0 200 225</b>
<b>Technical data:</b> Suction capacity, free-blowing: 130 m <sup>3</sup> /h Suction capacity, effective: 20 – 100 m <sup>3</sup> /h Max. compression: 1,900 Pa Motor: constant running Connection: 90 – 264 V, 50/60 Hz Motor output: 0.05 kW Noise level: approx. 58 dB(A) Weight: approx. 17 kg Dimensions (W x H x D): 300 x 315 x 300 mm Colour: RAL 7035 Suction connectors: 2 (rear) Suction connectors for arm: optional Filter equipment: combination filter: suspended matter/activated charcoal filter (Order No. 0 200 227)			

### Accessories / spare parts

	Order No.	Price from 1 piece	1 set
<b>Lid JF 5 with suction arm flex NW50</b>			
	Black, 900 mm, 2 articulations	<b>0 200 185</b>	
<b>Flat shield kit with table holder</b>			
	system 50, transparent, 330 x 240 mm, without suction hose	<b>0 200 152</b>	
<b>Hose set</b>			
	length 2.5 m, incl. connecting sleeve	<b>0 200 153</b>	
<b>Combination filter: suspended matter/activated charcoal filter</b>			
		<b>0 200 227</b>	









**An electronic display opens up new possibilities!**

- Filter monitoring
- Turbine monitoring
- Fault messages
- Speed control by tip function
- Clear and user-friendly visualisation of all data on a colour display



## Suction units

### Accessories

		Order No.	Price from 1 piece
<b>Suction arm for table mounting</b>	850 mm long, 3 joints, with throttle valve, anodised aluminium tubes, incl. table bracket and 2.5 m hose	<b>0 200 268</b>	
			
<b>Welding nozzle for suction arm</b>	310 mm long, anodised aluminium	<b>0 200 243</b>	
			
<b>Suction shield for suction arm</b>	Ø 200 mm	<b>0 200 248</b>	
			
<b>Suction shield</b>	Extraction bonnet for extraction arm, transparent rectangular, 245 x 220 mm, polycarbonate	<b>0 200 244</b>	
			
<b>Connecting hose NW 44</b>	2.5 m, NW 44 connecting sleeves on both sides	<b>0 200 247</b>	
			
<b>Connecting hose NW 44/NW50</b>	2.5 m incl. connection sleeve for connecting a suction arm/suction tip outer Ø 50 mm to a suction system	<b>0 200 247-3</b>	
			

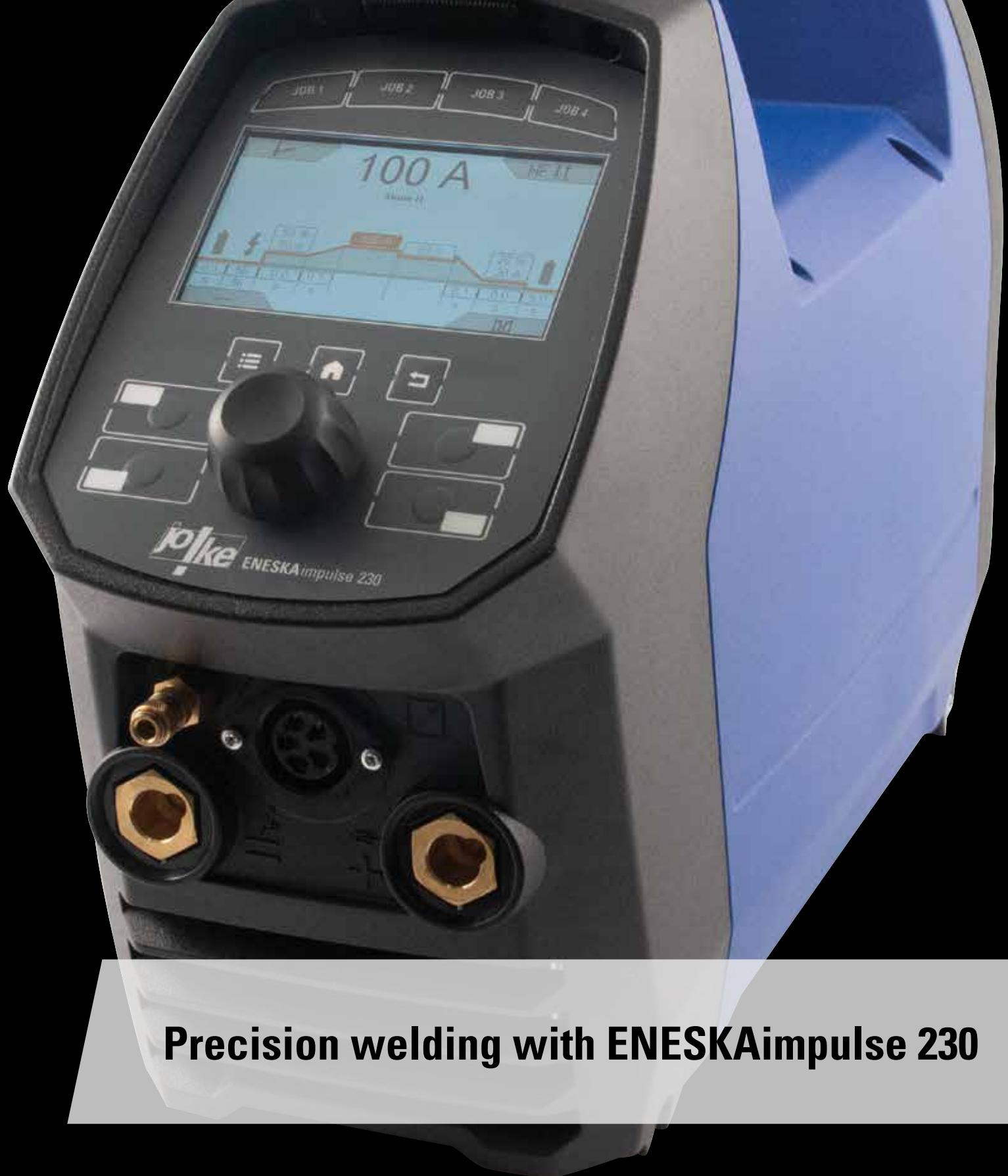

## Precision welding with ENESKAimpulse 230

Further information:

joke welding team

**Fabian Bickenbach** | head of welding technology

Tel. +49 2204 893-32 | Mail: [f.bickenbach@joke.de](mailto:f.bickenbach@joke.de)

# Deburring box JK19



Price from

Order No. 1 piece

**Deburring box JK19**

Deburring box JK 19 for connection to an extraction system

**0 200 894**

With integrated lighting, air gun  
and access openings with vertical blinds.  
Large working area with small external dimensions.

## Technical data:

Dimensions (W x D x H): 600 x 400 x 300 mm  
Supply voltage: 230 V, 50 Hz  
Exhaust air connector: rear, Ø 50 mm  
Weight: 15 kg

 *Accessories / spare parts*

Price from

Order No. 1 piece

**Additional magnifying glass, with vacuum suction cup**

2.5x working magnifier with integrated 10x detail area  
Vacuum base can be positioned on all smooth surfaces

**0 200 894-1**

magnifying glass: 2.5 x Ø 125 mm / 10 x Ø 25 mm  
suction cup: 55 mm

**LED spotlight**

Super-bright LED spotlight

**0 200 894-2**

Very flexible due to magnetic base  
and swiveling possibility

- Daylight quality
- 200 lumens
- 7 watts
- 100/240 V, 50/60 Hz

# Deburring box JK15

## Deburring box JK15

The compact, semi-closed unit is designed for use during deburring, polishing and grinding work tasks on small workpieces. The deburring box is used among modellers and mould builders, jewellers, dental technicians, laboratory technicians, etc.

The lighted work chamber illuminated by a pivotable LED light has a compressed-air nozzle with variable air volume, which is adjustable by means of a ball joint. The air nozzle ensures that dust and dirt are directed away from the workpiece towards the suction nozzle. The unit has a connection for 4 mm compressed-air lines and a 4 mm to 6 mm adapter is also included in the scope of delivery.

At the rear, a suction unit can be connected to the exhaust air connector (Ø 57 mm) via a hose.

The polycarbonate shields can be folded open for easy cleaning of the box. The system is rounded off by the folding magnifier, a removable collecting tray and the padded armrests.

# 7

	Order No.	Price from 1 piece
<b>Deburring box JK15</b>		



with integrated LED lighting, padded armrests, air nozzle and magnifying glass attachment **0 200 896**

Technical data:	
Air nozzle:	Air flow and position adjustable
Air connection:	Ø 4 / 6 mm at rear
Magnifying glass:	2.5 x Ø 125 mm / 10 x Ø 25 mm
Exhaust air connector:	Ø 57 mm at rear
Dimensions (W x D x H):	270 x 250 x 290 mm
Supply voltage:	230 V, 50/60 Hz
Weight:	5 kg

## ⚙️ Accessories / spare parts

	Order No.	Price from 1 piece
<b>Flexible reducing sleeve</b>		
clamping range 48-73 mm / 35-60 mm	<b>0 200 891</b>	





# Microscopes and test devices

- 519 Stereomicroscopes
- 524 Digital picture storage
- 527 Cold light sources
- 530 Magnifying glasses



# Stereomicroscopes

## System overview SM-200 • SM-101

### Stereomicroscope SM-200

**Rubber protectors**  
Order no. 0 200 602

**Eyepiece 25 x**  
Order no. 0 200 610

**Eyepiece 10 x**  
Order no. 0 200 609

**LED ring light**  
Order no. 200 621

**LED ring light with segment switching**  
Order no. 200 623

**Lens 2,0 x**  
Order no. 0 200 612

**Lens 0,5 x**  
Order no. 0 200 611

**LCD 101 Display 9", integrated video-/ still-image camera**  
Order no. 0 200 665-5

**Digital video camera**  
Order no. 0 200 631-2  
Order no. 0 200 631-6

**SM-200 standard version**  
Order no. 0 200 600

**SM-200 standard version with camera barrel**  
Order no. 0 200 600-1

### Stereomicroscope SM-101

**LCD 101 Display 9", integrated video-/ still-image camera**  
Order no. 0 200 665-5

**Digital video camera**  
Order no. 0 200 631-2  
Order no. 0 200 631-6

**C mount adapter 0,35 x for SM 101**  
Order no. 0 200 663

**Lens 0,5 x**  
Order no. 0 200 663-5

**SM-101 standard version**  
Order no. 0 200 665-3

# Stereomicroscopes

## SM-200

### Stereomicroscopes

Our stereomicroscopes are used to visually magnify workpieces or their surfaces for observation and inspection. Furthermore, tasks such as microwelding or polishing work can be monitored and checked in terms of quality directly at the workpiece. You have a choice between the introductory model SM-101 and the thousand times over tried and trusted top model SM-200 with versatile possibilities.

The structure of the stereomicroscopes with two eyepieces and one lens allows three-dimensional representation of the surface observed. Consequently, differences in height on the observation level can in particular be plastically detected.

### Stereomicroscope SM-200

The stereomicroscope universally rotatable, pivotable and movable on columns can also be optimally erected over large workpieces without having to align the workpiece accordingly. The inspection area can be evenly illuminated by means of a ring light attachable to the lens. The working distance is increased to 160 mm when using a 0.5 x lens, which allows working under the microscope.

The optimum magnification for the respective view can be configured using eyepieces and lenses with different magnifying factors.



SM-200 with camera barrel

### Stereomicroscope SM-101

The little brother of the large microscope SM-200 is already equipped as standard with a camera barrel. Otherwise this microscope offers sophisticated technology too at an introductory price. No illumination is included in the scope of supply in the standard version. Suitable LED ring lights or cold light sources from our range can be optionally installed.

The ideal basis for a digital image archiving environment: it is possible to switch over as desired from a stereo view through the eyepieces to camera deployment. In this case, the object is only still visible in one eyepiece. By substituting the glass plate supplied for the black/white working plate, it is also possible to observe objects with the transmitted light method.



### Visible field Ø and working distance depending on the magnification

Microscope equipment	Magnification SM-101	Magnification SM-200	Visible field Ø	Working distance
<b>Eyepiece 10 x and lens 0.5 x</b>	3.5 - 22 x	3.25 - 22.5 x	Ø 8 - 54 mm	160 mm
<b>Eyepiece 25 x and lens 0.5 x</b>	8.75 - 56.25 x	8.125 - 56.25 x	Ø 5.3 - 30 mm	
<b>Eyepiece 10 x and lens 0 x</b>	7 - 45 x	6.5 - 45 x	Ø 4 - 27 mm	90 mm
<b>Eyepiece 10 x and lens 2 x</b>	14 - 90 x	13 - 90 x	Ø 2.6 - 18 mm	
<b>Eyepiece 25 x and lens 0 x</b>	17.5 - 112.5 x	16.25 - 112.5 x	Ø 2 - 13 mm	25 mm
<b>Eyepiece 25 x and lens 2 x</b>	35 - 225 x	32.5 - 225 x	Ø 1.3 - 7 mm	



# Stereomicroscopes SM-101



### Stereomicroscope SM-101 with camera barrel

Design	with trinocular connection
Foot plate dimensions	285 x 238 mm
Dioptres	-5 to +5 dpt
Magnification	7 to 45 x
Working distance	approx. 100 mm (165 mm with 0.5x lens)
Dimensions	285 x 238 mm
Weight	5.5 kg
Scope of delivery	Basic device with 0.7 to 4.5x magnification (continuously adjustable), 2 x eyepiece with 10 x magnification, without lighting
Order No.	<b>0 200 665-3</b>
Price	



### ⚙️ Accessories / spare parts

	Order No.	Price from 1 piece
<b>C-Mount Adapter</b>		
	0.35x for microscop 101 (0200665-3) with bayonet connection Ø 38 mm, Trinocular	<b>0 200 663-1</b>
<b>Objectiv</b>		
	0.5x for microscop 101 (0 200 665-3) Trinocular	<b>0 200 663-5</b>
	2.0x for stereomicroscope 101 (0 200 665-3) Trinocular	<b>0 200 663-4</b>



# Stereomicroscopes

## SM-200



	Design	Order No.	Price from 1 piece
<b>Stereomicroscope SM-200</b>			
	without camera barrel	<b>0 200 600</b>	
	with camera barrel	<b>0 200 600-1</b>	
			
<p>Foot plate dimensions: 253 x 253 mm</p> <p>Dioptres: -3 to +3 dpt</p> <p>Magnification: 3.25 to 225x</p> <p>Working distance: approx. 30 to 150 mm</p> <p>Travel: vert. 430 mm, horiz. 420 mm</p> <p>Fine adjustment: vert. 66 mm, horiz. 57 mm</p> <p>Weight: 25 kg</p> <p>Scope of delivery: Basic device with 0.65 to 4.5 x magnification (continuously adjustable), 2 x eyepieces with 10 x magnification, lens protection cap, ring light (LED)</p>			
<p>Foot plate dimensions: 253 x 253 mm</p> <p>Dioptres: -3 to +3 dpt</p> <p>Magnification: 3.25 to 225x</p> <p>Working distance: approx. 30 to 150 mm</p> <p>Travel: vert. 430 mm, horiz. 420 mm</p> <p>Fine adjustment: vert. 66 mm, horiz. 57 mm</p> <p>Weight: 25 kg</p> <p>Scope of delivery: Basic device with 0.65 to 4.5 x magnification (continuously adjustable), 2 x eyepieces with 10 x magnification, lens protection cap, ring light (LED)</p>			

### Accessories / spare parts

	Packing quantity	Order No.	Price from 1 piece	1 set
	<b>Rubber protectors</b>			
	2 pieces	<b>0 200 602</b>		
	<b>Eyepiece 10 x</b>			
	2 pieces	<b>0 200 609</b>		
	<b>Eyepiece 25 x</b>			
	2 pieces	<b>0 200 610</b>		
	<b>Objectiv 0.5 x</b>			
		<b>0 200 611</b>		
	<b>Objectiv 2.0 x</b>			
		<b>0 200 612</b>		



# Stereomicroscope with switchable magnetic base and flex arm

## Stereomicroscope with switchable magnetic base and flex arm

The stand is equipped with a switchable magnetic base. Its high magnetic clamping force of 800 N guarantees a secure hold. The large working distance allows comfortable work under the microscope. The 3-axis flex arm allows setting to any desired position.

	Order No.	Price from
		1 piece

### Stereomicroscope, view 45° with switchable magnetic base and flex arm



Magnification:	10x	<b>0 200 601</b>
View:	4	5°
Working distance:	approx. 225 mm	
Visual field:	approx. 20 mm	
Magnetic base (WxLxH):	50 x 60 x 55 mm	
Magnetic force:	800 N	
Flex arm length L1 / L2:	133 / 113 mm	
incl. Eyepieces 10x and lens 1x		

	Order No.	Price from
		1 piece

### Stereomicroscope, view 0° straight, with switchable magnetic base and flex arm



Magnification:	10/20x	<b>0 200 601-2</b>
View:	0°	
Working distance:	approx. 70 mm	
Visual field:	approx. 10 mm	
Magnetic base (WxLxH):	50 x 60 x 55 mm	
Magnetic force:	800 N	
Flex arm length L1 / L2:	133 / 113 mm	
incl. Eyepieces 10x / 5x and lens 2x		





## Digital video camera for stereomicroscopes

### Digital image archiving

The stereomicroscopes with a camera barrel are prepared for use with digital cameras.

Using the set of digital video camera and software, you can either cleanly archive the images or additionally process, measure and analyse etc. the latter using the special software. The camera is fitted to the camera barrel of the microscope using the C-mount adapter. The camera can also be installed on conventional microscopes without barrel using the adapter likewise supplied. It is installed in this case in front of the eyepieces of the microscope.

Both cameras can be connected to a PC via USB. The HD camera also enables you to observe brilliant images live on the screen via HDMI or save them on an SD card.

	Order No.	Price from 1 piece
<b>Digital USB-2 camera with software</b>		
 <p>Live transfer of your microscope results to your PC.</p> <p><b>0 200 631-2</b></p> <p>Technical data:            Resolution: 5 megapixels (2,048 x 1,536 px)            Connection: USB 2.0</p> <p>Scope of delivery:</p> <ul style="list-style-type: none"> <li>• Image processing software</li> <li>• USB cable</li> <li>• 1/2" CMOS for installing the camera on microscopes using a C-mount adapter</li> <li>• incl. 2 eyepiece adapter Ø 30 and Ø 30.5 mm</li> <li>• Objectiv 0.45 x 5 fps (2,592 x 1,944 px) – 38 fps (640 x 480 px)</li> <li>• Calibration measuring plate</li> </ul>		

	Order No.	Price from 1 piece
<b>Multiple HDMI/USB/SD-card microscope camera, HD-Ultra</b>		
 <p>• Live via HDMI (1980 x 1080) 60 images per second            • Live via USB/PC (1980 x 1080) 30 images per second            • SD card recording format 1980 x 1080, video HD 980 x 1080</p> <p>Scope of supply:</p> <ul style="list-style-type: none"> <li>• USB and HDMI cable</li> <li>• Stand-alone system, work without computer assistance possible</li> <li>• PC software</li> <li>• Onboard software / mouse control</li> <li>• Calibration measuring plate</li> </ul>	<b>0 200 631-6</b>	



# Stereomicroscope Display LCD 101

## Saving of images and videos

This LCD screen can be connected to a trinocular microscope via c-mount adapter or to all conventional microscopes via an eyepiece adapter (0 200 657). The LCD 101 allows easy and convenient viewing of the specimen live on the screen. Onboard software allows to capture and save images and movies to a microSD-card.

Price from  
Order No. 1 piece

### Stereomicroscope-Camera with 9" LCD screen

0 200 665-5

- Full HDMI 1080P, 60 frames per second, video 30 FPS
- Recording format microSD-card
- stand-alone system, working without computer support possible
- onboard software / operation by mouse

Scope of delivery: LCD screen 9" incl. USB mouse, on-board control, USB cable



Menus left side & bottom of screen  
Onboard-Software | Mouse controlled



check captured photos / video records  
and compare them in split windows

## LED ring lights for stereomicroscopes

### LED ring lights for stereomicroscopes

When working under a stereomicroscope, a good ring light is virtually part of the basic equipment, in order to guarantee correct illumination of the workplace and above all the object being viewed. Up to now, either neon lights or the professional variant cold lights have been used for this purpose.

Thanks to ultra modern LED technology, there is now a great alternative: the new LED ring lights from joke. Owing to their LED's, these are not only brighter and more precise in illumination, they are also more economical and "live" longer.

Two versions of the LED ring lights are available. One with 48 LED's and adjustable luminous intensity. The other version has 60 LED's, switchable in 4 segments, with adjustable luminosity (not in segmental operation).

The ring lights are delivered completely ready to use with everything that you need to mount them on the microscope.



Use of the LED ring light with segmental switching on the SM-200 stereomicroscope

	Order No.	Price from 1 piece
<b>Ring light (48 LED's)</b>		
	Working distance: 50 – 150 mm Internal: Ø 60 mm Colour temperature: 6,000 K Luminous intensity (adjustable): 12.000 Lux at 80 mm distance Bulb life: > 100,000 h Connection: 100 – 240 V, 50/60 Hz Output voltage: 24 V, DC, 250 mA Material: Housing made of robust plastic Scope of delivery: Power supply unit and connection cable	<b>0 200 621</b>

Model 1: ring light with 48 LED's.

	Order No.	Price from 1 piece
<b>Ring light (60 LED's), individually switchable in 4 segments</b>		
	Working distance: 50 – 150 mm Internal Ø: 60 mm Colour temperature: 6.500 K Luminous intensity (adjustable): 16.000 lux at 100 mm distance Bulb life: > 100,000 h Connection: 100 – 240 V, 50/60 Hz Output voltage: 12 V, DC, 400 mA Material: Housing made of aluminium Scope of delivery: Power supply unit and connection cable	<b>0 200 623</b>

Model 2: ring light with 60 LED's individually switchable in four segments (15 LED's respectively).

## Cold light source LED

### Cold light source LED

Light source with two independent goosenecked guides equipped with 2 x 3 watts, white 6,500 K power LEDs

- Each LED guide with a gooseneck is equipped with a 3D lens focusing head, and has a length of 56 cm
- The light source version does not require a light-bulb change, unlike halogen light sources, has as a longer service life, and low electricity consumption
- The light source generates white light, and when dimmed there is no colour temperature change



		Price from
		Order No. 1 piece
<b>Cold light source LED</b>		<b>0 200 750-2</b>
Colour temperature:	6,500 K	
Light flux:	25,000 lux	
Operating voltage:	100 to 240 V AC / 5 V DC (50/60 Hz) automatic switching	
Dimensions (W x D x H):	106 mm x 140 mm x 70 mm	
Weight:	1.5 kg	



# Cold light source

## P 100 W







Cold light source P 100 W

Powerful cold light source 100 watts of luminous power. Longlife illuminants as accessories are optionally available.

In this model, the brightness can be continuously adjusted by a rotary switch. The cold light sources are optionally available without, with a single or double goosenecked light guide.

	Design	Order No.	Price from 1 piece
<b>Cold light source P 100 W</b>			
	Lamp: Halogen 100 W, 12 V Colour temperature: 3,200 K Bulb life: approx. 50 h Light brightness: by rotary switch Cooling: by fan Dimensions (W x H x D): approx. 110 x 155 x 240 mm Connection voltage: 230 V, 50/60 Hz Fuse: 1 A, slow blow Protection class: IP 20 Weight without light guide: approx. 4 kg Weight with light guide: approx. 4.4 kg	without swan-necked light guide	<b>0 200 710</b>
			

### ⚙️ Accessories / spare parts







		Order No.	Price from 1 piece
<b>Single gooseneck light guide, 53 cm</b>			
	self-sustaining		<b>0 200 730</b>
<b>Double gooseneck light guide, 53 cm</b>			
	self-sustaining		<b>0 200 720</b>
<b>Double gooseneck light guide, 70 cm</b>			
	self-sustaining		<b>0 200 741</b>
<b>XXL Flexlight for cold light sources</b>			
	For direct connection to our cold light sources. Delivery includes magnetic base for positioning on the workpiece in addition to two XXL swan necks (800 mm each) and flexible fibreglass supply lead (2,000 mm). Cold light source not included in scope of supply.		<b>0 200 778</b>
	Suitable light source:	0 200 745 and 0 200 710	
<b>Focusing attachment</b>			
	suitable for all Ø 10 mm goosenecks		<b>0 200 737</b>
<b>Lens, aspherical</b>			
	Lens, aspherical.		<b>0 200 739</b>
	Matched to the focusing attachment 0 200 737, the lens enables the light to be more strongly focused and concentrated on the object to be illuminated.		
<b>Illuminant, halogen 100 W</b>			
			<b>0 200 721</b>
<b>Illuminant, halogen 100 W, "Longlife" (approx. 1,500 h)</b>			
	Lamp service life approx. 1,500 h, colour temperature 3,050 K		<b>0 200 725</b>



## Cold light source Power-LED

	Design	Order No.	Price from 1 piece
<b>Cold light source LED, 30 W Power LED</b>			
	Lamp: Power-LED 30 W Colour temperature: 6,500 K Bulb life: approx. 25,000 h Light brightness: by rotary switch Cooling: by fan Connection voltage: 100 – 240 V, 50/60 Hz Fuse: 1.25 A, slow-blow Protection class: IP 20  Gooseneck not included	without swan-necked light guide	<b>0 200 745</b>

### Accessories / spare parts

		Order No.	Price from 1 piece
<b>Single gooseneck light guide, 53 cm</b>			
	self-sustaining		<b>0 200 730</b>
<b>Double gooseneck light guide, 53 cm</b>			
	self-sustaining		<b>0 200 720</b>
<b>Double gooseneck light guide, 70 cm</b>			
	self-sustaining		<b>0 200 741</b>
<b>XXL Flexlight for cold light sources</b>			
	For direct connection to our cold light sources. Delivery includes magnetic base for positioning on the workpiece in addition to two XXL swan necks (800 mm each) and flexible fibreglass supply lead (2,000 mm). Cold light source not included in scope of supply.  Suitable light source: 0 200 745 and 0 200 710		<b>0 200 778</b>
<b>Focusing attachment</b>			
	suitable for all Ø 10 mm goosenecks		<b>0 200 737</b>
<b>Lens, aspherical</b>			
	Lens, aspherical.  Matched to the focusing attachment 0 200 737, the lens enables the light to be more strongly focused and concentrated on the object to be illuminated.		<b>0 200 739</b>



# Magnifying spectacles

## MD 2011

### Magnifying spectacles MD 2011

Ergonomical, practical and good best sums up the magnifying spectacles MD 2011. They are extremely simple to use, not complicated adjustment to the wearer's own eyes is required. This is made possible by the wide pupillary distance (PD) range. The wide focussing range also allows good optical image quality. Owing to the adjustable sidepiece ends, the magnifying spectacles MD 2011 always fit perfectly without slipping. Also suitable for spectacle wearers, since the diopter compensation can be adjusted independently for the right and left side.

#### Applications:

- Model and mould building
- Quality control
- Watchmakers
- Restoration work
- Soldering workplaces
- etc.

7

		Price from
		Order No. 1 piece
<b>Magnifying spectacles MD 2011</b>		
	Magnification: 2 x Working distance: ca. 400 mm PD range: 60 – 68 mm (PD = pupillary distance) Visual field: 10°, Ø 150 mm at 400 mm distance Diopter compensation: ± 3 dpt (right/left can be separately adjusted) Weight: 49 g	<b>0 203 124</b>

### ⚙️ Accessories / spare parts

		Price from
		Order No. 1 piece
<b>LED spotlight for magnifying spectacles MD 2011, incl. power supply</b>		
	Dimensions lamp: 32 x 20 x 34 mm, weight 11 g Dimensions battery housing: 90 x 55 x 40 mm, weight 60 g, without batteries Lighting intensity: 3200 lx in 250 mm, 1200 lx in 400 mm Light duration: approx. 8 hours in normal mode, 14 hours in ecomode Cable length: 1 m Batteries: 3 x AA	<b>0 203 121</b>
<b>LED spotlight with clip for spectacle wearers, incl. power supply</b>		
		<b>0 203 122</b>



LED light with clamp clip for glasses  
(Order no. 0 203 122)



LED light (Order no. 0 203 121)  
**Glasses not included in scope of delivery!**

## Binocular LED headband magnifying glass

### Binocular LED headband magnifying glass

This magnifying glass with a triple LED unit illuminates the entire working area very uniformly.

The very light but nevertheless robust metal frame contains prismatic, metal-mounted silicate glass lenses. The optics are scratchproof, resistant to most chemicals and solvents and are characterised by a very high depth of field. Like the optics, the housing is also resistant to chemicals and solvents.

The magnifying glass can be easily worn over glasses.

	Order No.	Price from
<b>Binocular LED headband magnifying glass set</b>		1 set
	Triple LED unit (colour temperature 6,000 K) for optimum illumination of the working area.  Magnification: 2 x, 2.5 x and 3 x Working distance: 220, 170 und 130 mm Weight: approx. 140 g Scope of supply: headband magnifying glass with LED, 3 exchangeable lenses as a set in a case	<b>0 200 569</b>

## Visor-type magnifying glass

### Visor-type magnifying glass

Good things are sometimes as simple as this – and good value at the same time. This magnifying glass sits on your head like a baseball cap, leaving your hands free to do the work. The degree of magnification can be increased from 2 x to 3 x by simply adding another lens. When it is not needed, you can fold up the entire visor made of durable plastic, keeping the magnifying glass directly on your head for its next use.

	Order No.	Price from
<b>Visor-type magnifying glass</b>		1 piece
	Magnification range: 2 x or 3 x with additional fold-up additional lens Working distance: 450/340 mm Weight: approx. 100 g	<b>0 200 590</b>

## LED precision magnifying glass with leather storage case

### LED precision magnifying glass

The handy magnifying glass with integrated LED ring lighting. The 6 LED's illuminate the working area without casting a shadow; the optics consisting of 3 glass lenses guarantee corrected colour errors and provide distortion-free images. Power supply by 3 x LR927 round cell batteries.

	Ø lens	Magnification	Scope of delivery	Order No.	Price from 1 piece
<b>LED precision magnifying glass</b>					
	Ø 21 mm glass	10 x	magnifying glass, batteries, case	<b>0 200 538</b>	
	Ø 21 mm glass	20 x	magnifying glass, batteries, case	<b>0 200 528</b>	

### Accessories / spare parts

	Order No.	Price from 1 piece
<b>Battery LR 927</b>		<b>0 200 539</b>



## Watchmaker's magnifying glasses

### Watchmaker's magnifying glass

What's good enough for watchmakers is good enough for you: plastic casing, silicate glass lens. Available in three versions: 5 x / 7 x / 15 x magnification

	Ø lens	Magnification	Order No.	Price from 1 piece
<b>Watchmaker's magnifying glass (Plastic frame)</b>				
	Ø 16.3 mm	15 x	<b>0 200 582</b>	
	Ø 30 mm	5 x	<b>0 200 580</b>	
		7 x	<b>0 200 581</b>	
		10 x	<b>0 200 582-10</b>	

## Hand-held LED magnifiers

### LED hand-held illuminated magnifying glass

The mobile hand-held illuminated magnifying glass with the latest lighting technology and ergonomic shape. Optimum illumination is achieved with the 2-stage boost switch and a light colour of 4,500 K. Includes batteries and microfibre bags for storage and cleaning.

	Ø lens	Magnification	Order No.	Price from 1 piece
<b>Hand-held LED magnifiers</b>				
	Ø 22.8 mm	15 x	<b>0 200 589</b>	
	Ø 30 mm	8 x	<b>0 200 588</b>	
	Ø 30 mm	10 x	<b>0 200 588-2</b>	

## Inspection light sticks Boride® Rib-Light

### Inspection light sticks Boride® Rib-Light

The ideal lamp to light up hard to access places (ribs, bridges etc.). Handy like a ball point pen, you can be sure to find room in any shirt pocket. One push of the button is enough and the rib-lights deliver a very bright, precise light thanks to the LED technology. The lamps are available with and without goosenecks.

	Design	Order No.	Price from 1 piece
<b>Inspection light sticks Boride® Rib-Light</b>			
	available with and without gooseneck (190 mm long), stick length 155 mm, Ø 9 mm, white LED	with swan neck, white LED	<b>0 200 595</b>
		without swan neck, white LED	<b>0 200 597</b>

- 1
- 2
- 3
- 4
- 5
- 6

7

# Inspection devices

537 Inspection system

540 Light head and cold light lamp Mini



# Inspection system 2500

## System overview

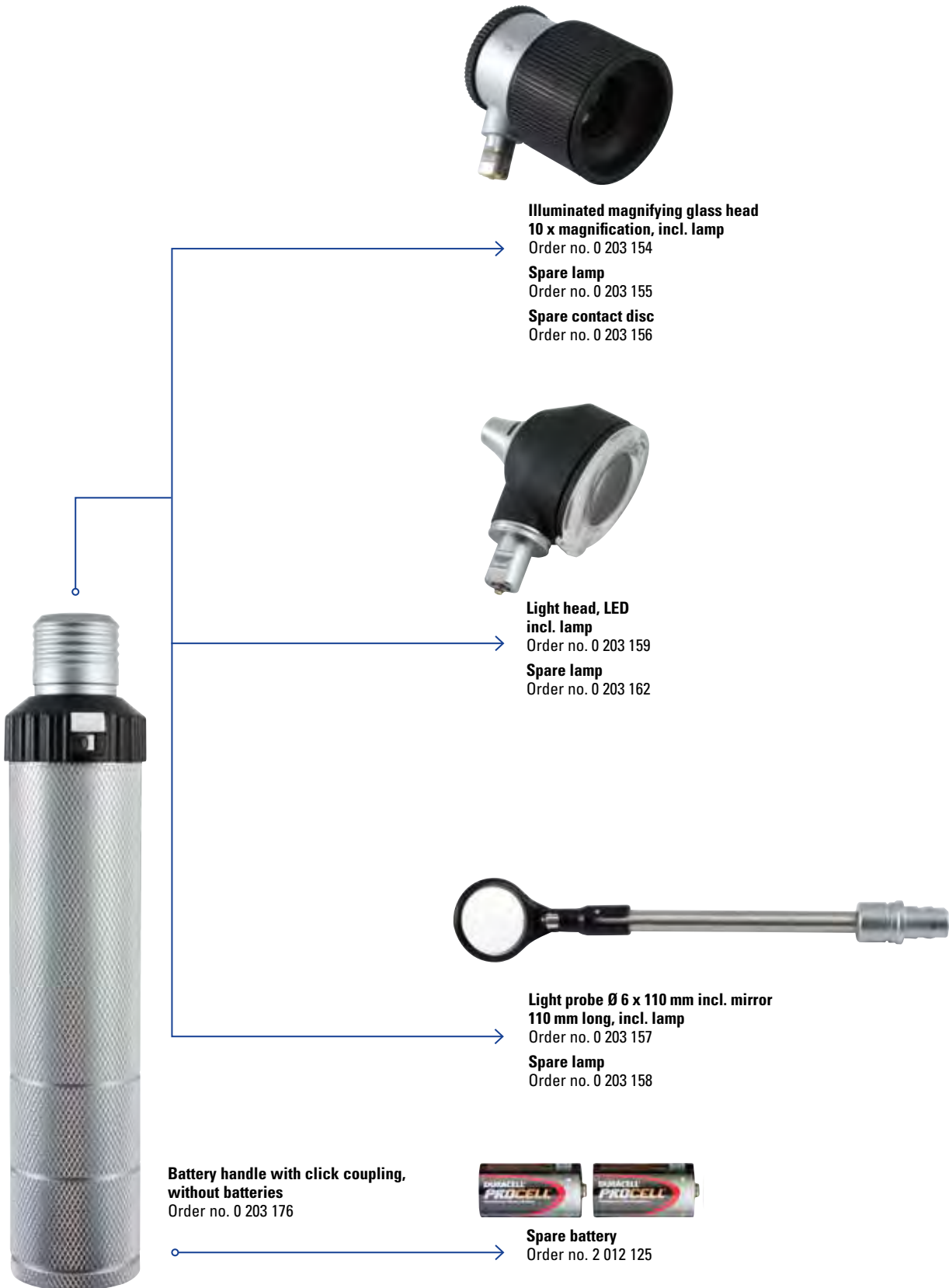



# Inspection system 2500



## Light head

### Inspection system 2500

The modular system offers you a wide range of inspection possibilities. Simply changing the inspection heads using the automatic click coupling provides you the right equipment for any application. The robust metal handle is supplied by 2 batteries. The 2.5-volt system is equipped with a high-power xenon light or high quality LED technology. The devices are used for observing surfaces, bores and cavities, etc.

	Order No.	Price from
<b>Illuminated magnifying glass with 10 x magnification</b>		1 piece
 <ul style="list-style-type: none"> <li>• click-on connection</li> <li>• xenon/halogen bulb</li> <li>• 2.5 V</li> <li>• focus adjustment –6 up to +3.5 dpt</li> <li>• large contact disk (Ø 25 mm) with scale setting for the measurement</li> <li>• uniform, intensive illumination</li> </ul>	<b>0 203 154</b>	

### ⚙️ Accessories / spare parts

	Order No.	Price from
<b>Spare lamp</b>		1 piece
 <p>Spare lamp 2.5 V, for light head 10 x, System 2500</p>	<b>0 203 155</b>	
<b>Spare contact disc</b>		
 <p>Spare contact disc (Ø 25 mm) with scaling for measurement</p>	<b>0 203 156</b>	

	Order No.	Price from
<b>Light probe Ø 6 x 110 mm incl. mirror</b>		1 piece
 <ul style="list-style-type: none"> <li>• click coupling</li> <li>• xenon</li> <li>• 2.5 V</li> </ul>	<b>0 203 157</b>	

### ⚙️ Accessories / spare parts

	Order No.	Price from
<b>Spare lamp 2.5 V, for light probe Ø 6 x 110 mm</b>		1 piece
 <p>Spare lamp 2,5 V for light probe Ø 6 x 110 mm, System 2500</p>	<b>0 203 158</b>	

# Inspection system 2500

## Light head

	Order No.	Price from
<b>Light head</b>		1 piece



- click-on connection
- LED bulb
- illuminance approx. 8,000 Lux
- lifetime approx. 100,000 h
- pivoting magnifying glass with 3-fold magnification
- direction of vision 0°

**0 203 159**

### Accessories / spare parts

	Order No.	Price from
<b>Spare lamp for light head (2.5 V)</b>		1 piece



Spare lamp 2,5 V for light head, LED, System 2500

**0 203 162**

	Order No.	Price from
<b>Battery handle for 2 batteries</b>		1 piece



- with click-on connection
- Ø 29 x 146 mm
- 2.5 V
- without batteries

**0 203 176**

#### Functional principle

The light of a lens bulb is projected onto the end surface of a bundle of optical fibres consisting of several thousand optical fibres. The fibres are arranged in a circle at the light emission point.

In this way a uniform and shadowless coaxial illumination of the field of view is generated.

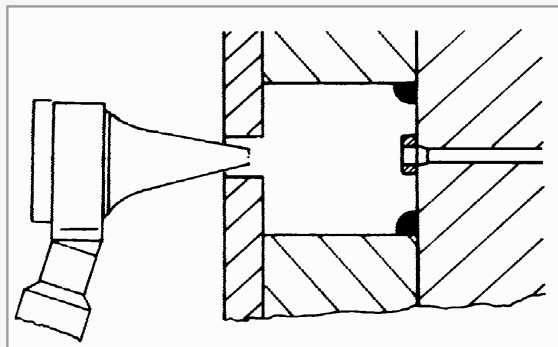

# Light head Mini

lightweight, practical and universally usable



Price from

Order No. 1 set

## Set Light head, Mini 2.5 V, LED, F.O. fibre optics

**0 203 150-1**

- Fibre optic LED lighting, very good colour rendering Ra > 94
- LED lamp life approx. 30,000 h
- Colour temperature 3,000 K
- Illuminance approx. 7,000 lux (distance 2 cm)
- Pivotal magnifying glass with 3 x magnification
- Viewing direction 0°

Scope of supply: Light attachment, battery handle for 2 x mignon type AA, without batteries, inspection funnel, 1 piece each: 10 x Ø 2.5 x 35 mm and 10 x Ø 4 x 30 mm

### ⚙️ Accessories / spare parts

Price from

Order No. 1 piece

## Spare lamp for light head (2.5 V)

**0 203 151-1**

# Cold light lamp Mini 3000

lightweight, practical and universally usable

### Cold light source Mini 3000

A lightweight, practical and universally usable instrument for visual control with outstanding illumination.

- Light rod length 100 mm
- Ø 2.5 mm probes



#### Applications:

- Inspecting blind holes
- Narrow slots in mould making
- Controlling injection moulding tools incorporated in the machine
- General testing

	Design	Order No.	Price from 1 piece
<b>Cold light lamp Mini 3000</b>			
incl. battery handle and 2 AA batteries	Ø 2.5 x 100 mm	<b>0 203 030-5</b>	
	Ø 5 x 100 mm	<b>0 203 031-5</b>	



### ⚙️ Accessories / spare parts

	Dimensions	Order No.	Price from 1 piece
<b>Spare lamp 2.5 V, XHL®</b>			
 suitable for Order No. 0 203 030-5 and 0 203 031-5		<b>0 203 030-1</b>	
<b>Glass mirror, clip-on</b>			
 suitable for Order No. 0 203 031-5	Ø 25 mm	<b>0 203 088-2</b>	
	Ø 16 mm	<b>0 203 038</b>	
	Ø 14.5 mm	<b>0 203 118</b>	
 suitable for Order No. 0 203 031-5	Ø 8 mm	<b>0 203 093-2</b>	

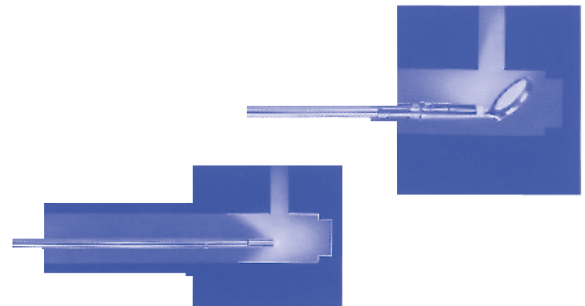

## Inspection lights

1000 lumen torch, 450 lumen inspection lamp, 300 lumen gooseneck lamp

### Inspection lights, set

- innovative 3-in-1 work light, interchangeable attachments, rechargeable
- magnetic base for hands-free work
- different light intensities adjustable via on/off button
- Torch and goosenecked lamp with adjustable focus, inspection lamp can be rotated and swivelled through 180° rotatable and pivotable
- goosenecked lamp with 350 mm long flexible neck for use in areas with restricted access.
- Storage battery: 3.7 V 2200 mAh Li-Ion
- Charging time: 7 hours
- Light output: torch/1000 lm, inspection lamp/450 lm, goosenecked lamp/300 lm
- Operating times (high):  
goosenecked lamp: 11 hours, inspection lamp: 4.2 hours, torch: 3.3 hours



	Order No.	Price from 1 piece
<b>LED inspection light, rechargeable</b>		
	<b>0 200 717</b>	
<b>Content of the set:</b> <ul style="list-style-type: none"> <li>• flashlight</li> <li>• inspection lamp</li> <li>• gooseneck lamp</li> <li>• USB cable</li> <li>in sturdy box</li> </ul>		



Tip: The battery power device **joke ENESKAmobile** and useful sets can be found on **page 48**

# Inspection lights

## LED Inspection penlight, pocket size

The handy and small inspection penlight fits in any trouser pocket or with the clip on a shirt. With the aid of the two light modes spot light and planar light, the light can either be focused on one spot, or an entire area can be illuminated. The pen-sized lamp is perfect for illuminating hard-to-reach places or narrow openings.

	Order No.	Price from
		1 piece

### LED inspection penlight, pocket size

- Powerful, precise and pocket-friendly pen light.
- 1W COB extremely bright light with up to 50 lumens power output
- 3W SMD side light with up to 55 lumen power
- Ideal for one hand use
- Length 142 mm / Weight 26 g
- Powered by 1 x AAA battery (not included)

**0 200 716**

